



EUROFINS PRODUCT TESTING SERVICE (SHANGHAI) CO., LTD

EMC TEST- REPORT

TEST REPORT NUMBER: EFSH17090053-IE-01-E01



Eurofins Product Testing Service (Shanghai) Co., Ltd
No. 395 West Jiangchang Road, Jing'an District,
Shanghai, China

Phone: +86-21-61819181
Fax: +86-21-61819299
Page 1 of 56

TABLE OF CONTENTS**1 Contents**

1	Contents	2
2	General Information	3
2.1	Notes	3
2.2	Testing laboratory	4
2.3	Details of approval holder	5
2.4	Application details	5
2.5	EUT information	5
2.6	Test standards	6
3	Technical test	7
3.1	Summary of test results	7
3.2	Test environment	7
3.3	List of Test equipment	8
3.4	Test results	11
4	Emission Test	12
4.1	Conducted Emission	12
	Model R63-6-XX/A125/19-8 test data	19
4.2	Radiated electromagnetic disturbances	21
4.3	Radiated disturbance	35
4.4	Voltage Changes, Voltage Fluctuations and Flicker	44
5	Immunity Test	46
5.1	Performance Criteria Description in Clause 4 of EN 61547	46
5.2	Conditions during testing	46
5.3	ESD	47
5.4	Radio frequency electromagnetic fields	48
5.5	Electrical Fast Transients	49
5.6	Injected currents(RF continues conducted)	50
5.7	Surge Immunity	51
5.8	Voltage dips and Interruption	52
6	Test setup Photos	53

2 General Information

2.1 Notes

The results of this test report relate exclusively to the item tested as specified in chapter "Description of test item" and are not transferable to any other test items.

Eurofins Product Testing Service (Shanghai) Co., Ltd. is not responsible for any generalisations and conclusions drawn from this report. Any modification of the test item can lead to invalidity of test results and this test report may therefore be not applicable to the modified test item.

The test report may only be reproduced or published in full. Reproducing or publishing extracts of the report requires the prior written approval of the Eurofins Product Testing Service (Shanghai) Co., Ltd.

This document is subject to the General Terms and Conditions and the Testing and Certification System of Eurofins Product Testing Service (Shanghai) Co., Ltd. available on request or accessible at www.pt.eurofins.com.

Operator:

2017-11-15

Perry Li / Testing Engineer



Date

Eurofins-Lab.

Name / Title

Signature

Technical responsibility for area of testing:

2017-11-15

Stefan Zhao / Project Engineer



Date

Eurofins

Name / Title

Signature

Test Report No.: EFSH17090053-IE-01-E01

Eurofins Product Testing Service (Shanghai) Co., Ltd
No. 395 West Jiangchang Road, Jing'an District, Shanghai, China

2.2 Testing laboratory

Eurofins Product Testing Service (Shanghai) Co., Ltd

No. 395 West Jiangchang Road, Jing'an District, Shanghai, China

Telephone : +86-21-61819181

Fax : +86-21-61819299

Test location, where different:

Name : Shenzhen SEM.Test Technology Co., Ltd.

Address : 1/F., Room 101, Building 1, Hongwei Industrial Park, Liuxian'er Road, Block 70,
Bao'an District, Shenzhen, Guangdong, China

Telephone : +86-755-3366 3308

Fax : +86-755-3366 3309

All items were prepared and tested at Shenzhen SEM.Test Technology Co., Ltd.

2.3 Details of approval holder

Name : Foshan Electrical and Lighting Co., Ltd.
Address : 64 North Fenjiang Road, Foshan, Guangdong, China
Telephone : ./.
Fax : ./.

2.4 Application details

Date of receipt of application : 2017-09-04
Date of receipt of test item : 2017-09-05
Date of test : 2017-09-06 to 2017-11-13

2.5 EUT information

Product type : LED Lamps
Model name : GU10-3.5-XX/K157/24, GU10-5-XX/K157/24,
GU10-6-XX/K157/24, GU10-3-XX/A159/17,
GU10-4-XX/A159/17, GU10-5-XX/A159/17,
GU10-6-XX/A159/17, R50-6-XX/A115/19-Y,
R63-6-XX/A125/19-Y
("XX" can be from 18 to 65, which is stand for different colour
temperature, from 1800K to 6500K;
"Y" can be 8 or 9, means CRI80 or CRI90)
Brand name : FSL
Serial number : ./.
Ratings : 100-240V~, 50/60Hz, GU10 cap
GU10-3.5-XX/K157/24: 3,5W; GU10-5-XX/K157/24: 5W;
GU10-6-XX/K157/24: 6W;

220-240V~, 50/60Hz, GU10 cap
GU10-3-XX/A159/17: 3W; GU10-4-XX/A159/17: 4W;
GU10-5-XX/A159/17: 5W; GU10-6-XX/A159/17: 6W

220-240V~, 50/60Hz, E14 cap
R50-6-XX/A115/19-Y: 6W

220-240V~, 50/60Hz, E27 cap
R63-6-XX/A125/19-Y: 6W;

Test voltage : AC 230V, 50Hz

Additional information :

1. The products in this report are LED lamps for indoor use only and the LED light source cannot be replaced.

2. There are four series in this report, the detail is following:

- 1) GU10-3.5-XX/K157/24, GU10-5-XX/K157/24, GU10-6-XX/K157/24;
- 2) GU10-3-XX/A159/17, GU10-4-XX/A159/17, GU10-5-XX/A159/17, GU10-6-XX/A159/17;
- 3) R50-6-XX/A115/19-Y;
- 4) R63-6-XX/A125/19-Y;

3. GU10-6-30/K157/24, GU10-6-30/A159/17, R50-6-30/A115/19-8 and R63-6-XX/A125/19-8 were chosen as the typical models to be applied to all tests

2.6 Test standards

Technical standard :

EN 55015:2013+A1:2015

EN 61547:2009

EN 61000-3-2:2014

EN 61000-3-3:2013

3 Technical test

3.1 Summary of test results

No deviations from the technical specification(s) were ascertained in the course of the tests performed.



or

The deviations as specified were ascertained in the course of the tests performed.



3.2 Test environment

Temperature	:	20	...	24°C
Relative humidity content	:	30	...	55%
Air pressure	:	100	...	103kPa

3.3 List of Test equipment

Equipment Name	Manufactory	Model	Serial No.	Cal Due date
EMI Test Receiver	Rohde & Schwarz	ESPI	101611	2018-03-27
Pulse Limiter	Rohde & Schwarz	ESH3-Z2	100911	2018-03-27
L.I.S.N	SCHWARZBECK	NSLK8126	8126-224	2018-03-27
L.I.S.N	EMCO	3825/2	11967C	/
Clamp	SCHWARZBECK	MDS21	3809	2018-03-27
Spectrum Analyzer	Rohde & Schwarz	FSEA20	DE25181	/
Test Receiver	Rohde & Schwarz	ESVB	825471/005	2018-03-27
Amplifier	Agilent	8447F	3113A06717	2018-03-27
RF Switch	EM	EMSW18	SW060023	/
Positioning Controller	C&C	CC-C-1F	/	/
Trilog Broadband Antenna	SCHWARZBECK	VULB9163	9163-333	2018-02-24
Horn Antenna	SCHWARZBECK	BBHX9120	9120	/
Loop Antenna	SCHWARZBECK	HFRA 5150	9453	/
Triple-Loop Antenna	EVERFINE	LLA-2	711001	2018-03-27
Coaxial Cable	SCHWARZBECK	AK9513	9513-10	/
Spectrum Analyzer	Agilent	E4402B	US41192821	2018-03-27
RF Limiter	Agilent	11867A	MY42241803	/
RMS/PEAK Voltmeter	Rohde & Schwarz	URE3	826135/008	/
INDUSTRIAL CONTROLLER	Rohde & Schwarz	PSP7	826033001	/
Attenuator	ATTEN	ATS100-4-20	/	/
Attenuator	ATTEN	ATS002-4-20	/	/
Attenuator	ATTEN	ATS010-4-30	/	/
ESD Generator	LIONSHI	ESD-203B	ESD203B 0170901	2018-09-02

Test Report No.: EFSH17090053-IE-01-E01

Transient 2000	EMC Partner	TRA2000	863	2018-03-27
Couple Clamp	EMC Partner	CN-EFT1000	513	2018-03-27
CDN	FRANKONIA	M2+M3	A3011104	/
Semi-Anechoic Chamber	SAEMC	966	/	/
Shielding Room	SAEMC	743	/	/
Shielding Room	SAEMC	443(TRIPLE LOOP ROOM)	/	/
Shielding Room	SAEMC	443(CONTR OL ROOM)	/	/
Power Divider	Weinschel	1506A	PM204	2018-03-27
Impedance Matching PADS	Weinschel	9070-50/75	/	/
Impedance Matching PADS	Weinschel	9070-50/75	/	/
Spectrum Analyzer	Rohde & Schwarz	FSP30	836079/035	2018-03-27
RF Current Probe	FCC	F-33-4	091684	2018-03-27
Attenuator	ATTEN	ATS010-4-10	/	/
GSM Tester	Rohde & Schwarz	CMU200	112012	2018-03-27
Coaxial Cable	SEM.Test	1M0RFC	AMP-SW	/
Coaxial Cable	SEM.Test	2M0RFC	966-AMP	/
Coaxial Cable	SCHWARZBECK	5M0RFC	CLAMP	/
Coaxial Cable	SEM.Test	2M4RFC	LISN	/
Coaxial Cable	SEM.Test	1M0RFC	SW-ESVB	/
Coaxial Cable	SEM.Test	0M4RFC	SW-FSP	/
EMI Test Software	Shurple	EZ-EMC-RA	SEM-V3A1	/
Horn Antenna	ETS	3117	00086197	2018-02-24
Pre-amplifier	Compliance Direction	PAP-1G18	24002	2018-03-27
Coaxial Cable	Agilent	LL142-07-07-10M	08050035	/
CS Immunity Tester	EMTEST	CWS500	0900-03	2018-03-27

Test Report No.: EFSH17090053-IE-01-E01

Eurofins Product Testing Service (Shanghai) Co., Ltd
No. 395 West Jiangchang Road, Jing'an District, Shanghai, China

Attenuator	EMTEST	MA-5100/6BF2	1009	2018-03-27
CDN	Luthi	L-801M2/M3	2665	2018-03-27
RF Limiter	ATTEN	AT-BSF-2400~2500	/	/
RF Limiter	ATTEN	AT-BSF-0136~0174	/	/
RF Limiter	ATTEN	AT-BSF-0400~0500	/	/
RF Limiter	ATTEN	AT-BSF-0820~0920	/	/
RF Limiter	ATTEN	AT-BSF-1710~1910	/	/
Coaxial Load	ATTEN	ATF010-2	/	/
Combine Power	ATTEN	ATGF50-2.5-20	11300100205702	/
Signal Generator	HP	8648A	3642U01277	/
Digital Power Analyzer	California Instrument	CTS	72831	/
Power Source	California Instrument	5001IX-CTS-400	60077	2018-03-27
Cell Site Test Set	HP	8921A	3524A02414	2018-03-27
Coaxial Attenuator	ATTEN	ATS002-4-6	/	/

3.4 Test results

 1st test

 test after modification

 production test

Test case	Sub clause	Required	Test passed	Test failed
Conducted Emission	Clause 4.3 of EN 55015	<input checked="" type="checkbox"/>	<input checked="" type="checkbox"/>	<input type="checkbox"/>
Radiated electromagnetic disturbances	Clause 4.4 of EN 55015	<input checked="" type="checkbox"/>	<input checked="" type="checkbox"/>	<input type="checkbox"/>
Radiated disturbance	Clause 4.4.2 of EN 55015	<input checked="" type="checkbox"/>	<input checked="" type="checkbox"/>	<input type="checkbox"/>
Harmonic Current Emissions	EN 61000-3-2	<input type="checkbox"/>	<input type="checkbox"/>	<input type="checkbox"/>
Voltage Changes, Voltage Fluctuations and Flicker	EN 61000-3-3	<input checked="" type="checkbox"/>	<input checked="" type="checkbox"/>	<input type="checkbox"/>
Electrostatic Discharge	Clause 5.2 of EN 61547 & IEC 61000-4-2	<input checked="" type="checkbox"/>	<input checked="" type="checkbox"/>	<input type="checkbox"/>
Radio frequency electromagnetic fields	Clause 5.3 of EN 61547 & IEC 61000-4-3	<input checked="" type="checkbox"/>	<input checked="" type="checkbox"/>	<input type="checkbox"/>
Power frequency magnetic fields	Clause 5.4 of EN 61547 & IEC 61000-4-8	<input type="checkbox"/>	<input type="checkbox"/>	<input type="checkbox"/>
Electrical Fast Transients	Clause 5.5 of EN 61547 & IEC 61000-4-4	<input checked="" type="checkbox"/>	<input checked="" type="checkbox"/>	<input type="checkbox"/>
Injected currents (RF common mode)	Clause 5.6 of EN 61547 & IEC 61000-4-6	<input checked="" type="checkbox"/>	<input checked="" type="checkbox"/>	<input type="checkbox"/>
Surge immunity	Clause 5.7 of EN 61547 & IEC 61000-4-5	<input checked="" type="checkbox"/>	<input checked="" type="checkbox"/>	<input type="checkbox"/>
Voltage dips and short interruption	Clause 5.8 of EN 61547 & IEC 61000-4-11	<input checked="" type="checkbox"/>	<input checked="" type="checkbox"/>	<input type="checkbox"/>

Note:

1. Power frequency magnetic fields test was not required as the EUT did not contained components susceptible to magnetic fields.
2. The EUT is LED light power < 25W, which doesn't belong to discharge lighting equipment, thus harmonic current emission test is not applicable according to EN 61000-3-2 requirement.

4 Emission Test

4.1 Conducted Emission

This clause lays down the general requirements for the measurement of disturbance voltage produced at the terminals of apparatus.

4.1.1 Limits

Frequency range MHz	At mains terminals dB (μ V)	
	Quasi-peak	Average
0.009 to 0.05	110	--
0.05 to 0.15	90 to 80	--
0.15 to 0.50	66 to 56	56 to 46
0.50 to 5	56	46
5 to 30	60	50

Note1: The limit decreases linearly with the logarithm of the frequency in the range 50k to 150kHz and 150 kHz to 0.5 MHz.

Note2: The lower limit is applicable at the transition frequency.

4.1.2 Measurement procedure

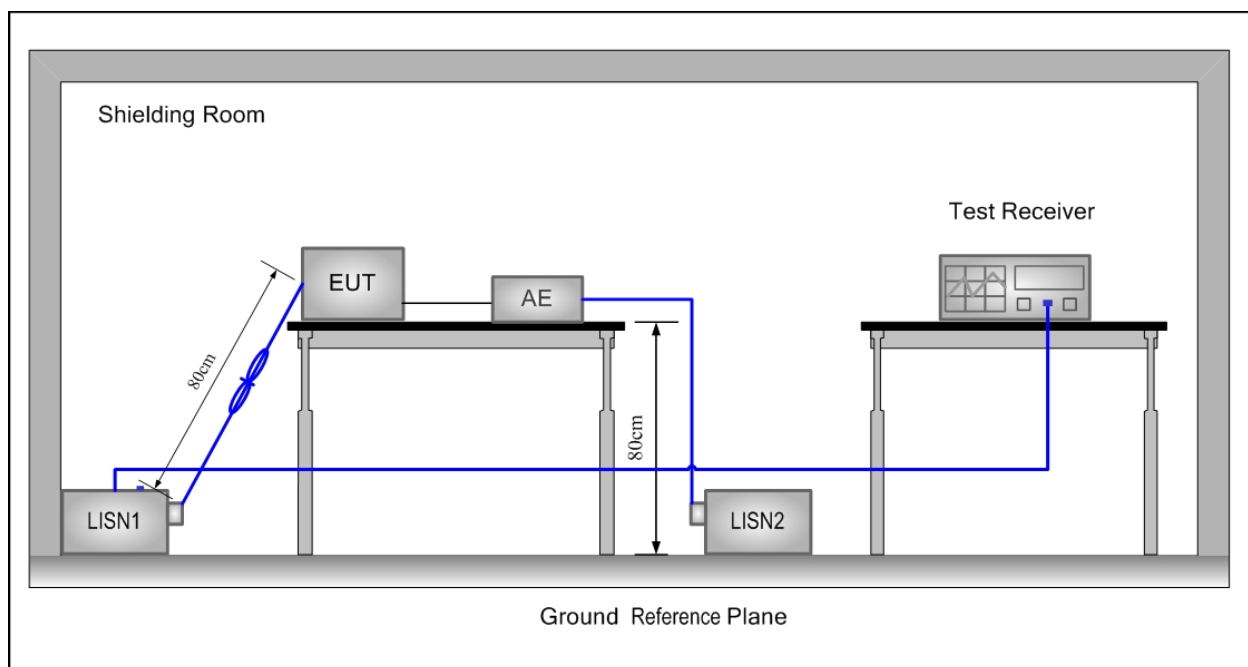

1. The mains terminal disturbance voltage was measured with the EUT in a shielded room.
2. The EUT was connected to AC power source through a LISN (Line Impedance Stabilization Network) which provides a $(50 \mu\text{H} + 5 \Omega) \parallel 50 \Omega$ linear impedance. The power cables of all other units of the EUT were connected to a second LISN, which was bonded to the ground reference plane in the same way as the LISN for the unit being measured.

- The table top EUT was placed upon a non-metallic table 0.8m above the ground reference plane. And for floor-standing arrangement, the EUT was placed on the horizontal ground reference plane, but separated from metallic contact with the ground reference plane by 0.1m of insulation.
- Before get the final emission results with quasi-peak(QP) detector and average(AV) detector, a pre-scan was performed with the peak(PK) and average(AV) detector to find out the maximum emission data plots of the EUT.

4.1.3 Measurement uncertainty

U_{lab}(cond) = 1.8dB at 95% level of confidence, k=2

4.1.4 Results -Measurement Data

Model GU10-6-30/K157/24 test data

Job No.:	CE	Phase:	L1
Standard:	EN55015 Conduction(QP)	Power Source:	AC 230V/50Hz
Test item:	Conduction Test	Date:	2017/09/06
Temp.(°C)/Hum.(%RH):	26°C/60%RH	Time:	16:58:21
Note:			

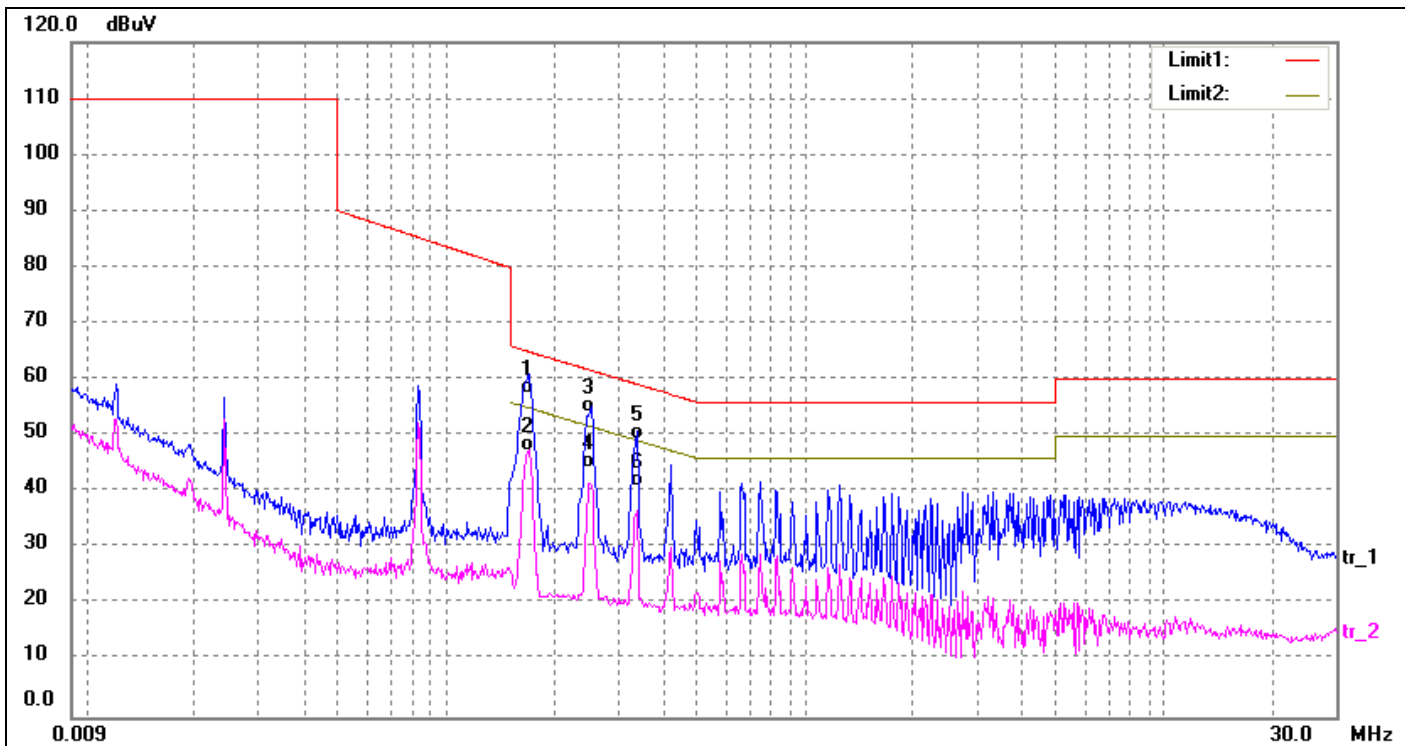

No.	Frequency (MHz)	Reading (dBuV)	Correct (dB)	Result (dBuV)	Limit (dBuV)	Over (dB)	Detector
1	0.1642	47.69	9.84	57.53	65.25	-7.72	QP
2	0.1642	37.30	9.84	47.14	55.25	-8.11	AVG
3*	0.2540	44.45	9.80	54.25	61.63	-7.38	QP
4	0.2540	34.45	9.80	44.25	51.63	-7.38	AVG
5	0.3380	39.67	9.80	49.47	59.25	-9.78	QP
6	0.3380	31.12	9.80	40.92	49.25	-8.33	AVG

Job No.:	CE	Phase:	N
----------	----	--------	---

Test Report No.: EFSH17090053-IE-01-E01

Eurofins Product Testing Service (Shanghai) Co., Ltd
No. 395 West Jiangchang Road, Jing'an District, Shanghai, China

Standard:	EN55015 Conduction(QP)	Power Source:	AC 230V/50Hz
Test item:	Conduction Test	Date:	2017/09/06
Temp.(°C)/Hum.(%RH):	26°C/60%RH	Time:	16:51:03
Note:			

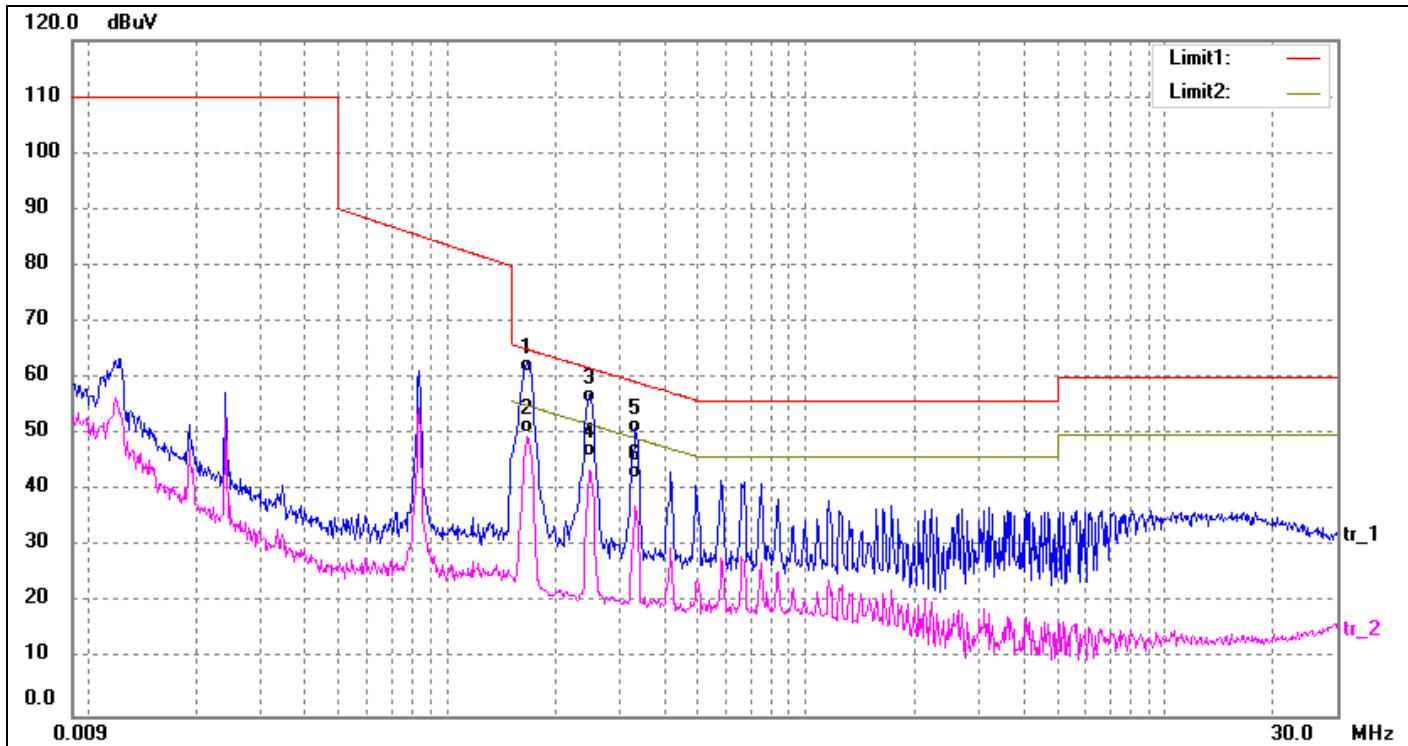

No.	Frequency (MHz)	Reading (dBuV)	Correct (dB)	Result (dBuV)	Limit (dBuV)	Over (dB)	Detector
1*	0.1660	51.32	9.83	61.15	65.16	-4.01	QP
2	0.1660	40.52	9.83	50.35	55.16	-4.81	AVG
3	0.2500	45.84	9.80	55.64	61.76	-6.12	QP
4	0.2500	36.12	9.80	45.92	51.76	-5.84	AVG
5	0.3340	40.58	9.80	50.38	59.35	-8.97	QP
6	0.3340	32.24	9.80	42.04	49.35	-7.31	AVG

Model GU10-6-30/A159/17 test data

Job No.:	CE	Phase:	L1
Standard:	EN55015 Conduction(QP)	Power Source:	AC 230V/50Hz
Test item:	Conduction Test	Date:	2017/09/06
Temp.(°C)/Hum.(%RH):	26°C/60%RH	Time:	16:37:34
Note:			

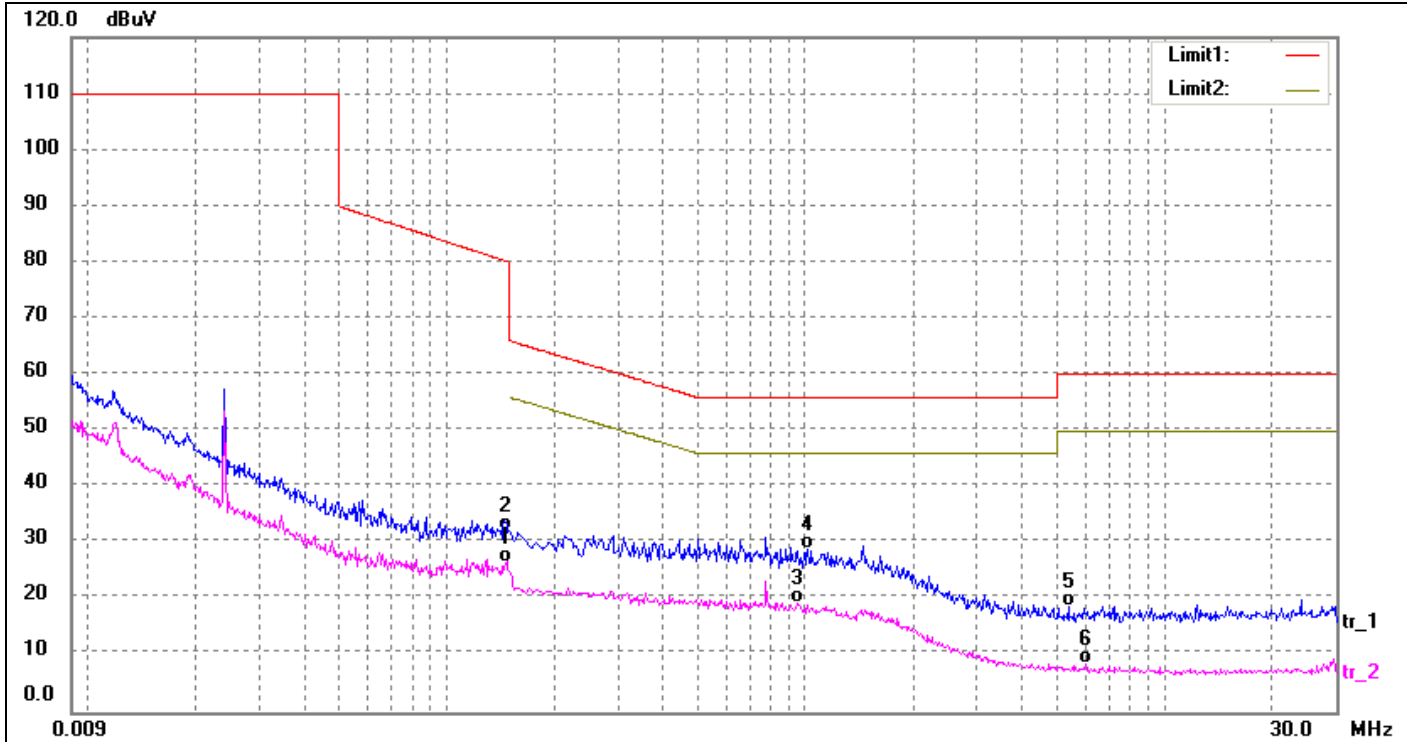

No.	Frequency (MHz)	Reading (dBuV)	Correct (dB)	Result (dBuV)	Limit (dBuV)	Over (dB)	Detector
1	0.1473	16.85	9.85	26.70	56.15	-29.45	AVG
2	0.1496	22.44	9.85	32.29	80.02	-47.73	QP
3*	0.9540	9.51	9.76	19.27	46.00	-26.73	AVG
4	1.0140	19.12	9.76	28.88	56.00	-27.12	QP
5	5.3980	9.21	9.65	18.86	60.00	-41.14	QP
6	6.0300	-1.08	9.63	8.55	50.00	-41.45	AVG

Job No.:	CE	Phase:	N
Standard:	EN55015 Conduction(QP)	Power Source:	AC 230V/50Hz
Test item:	Conduction Test	Date:	2017/09/06
Temp.(°C)/Hum.(%RH):	26°C/60%RH	Time:	16:44:01
Note:			

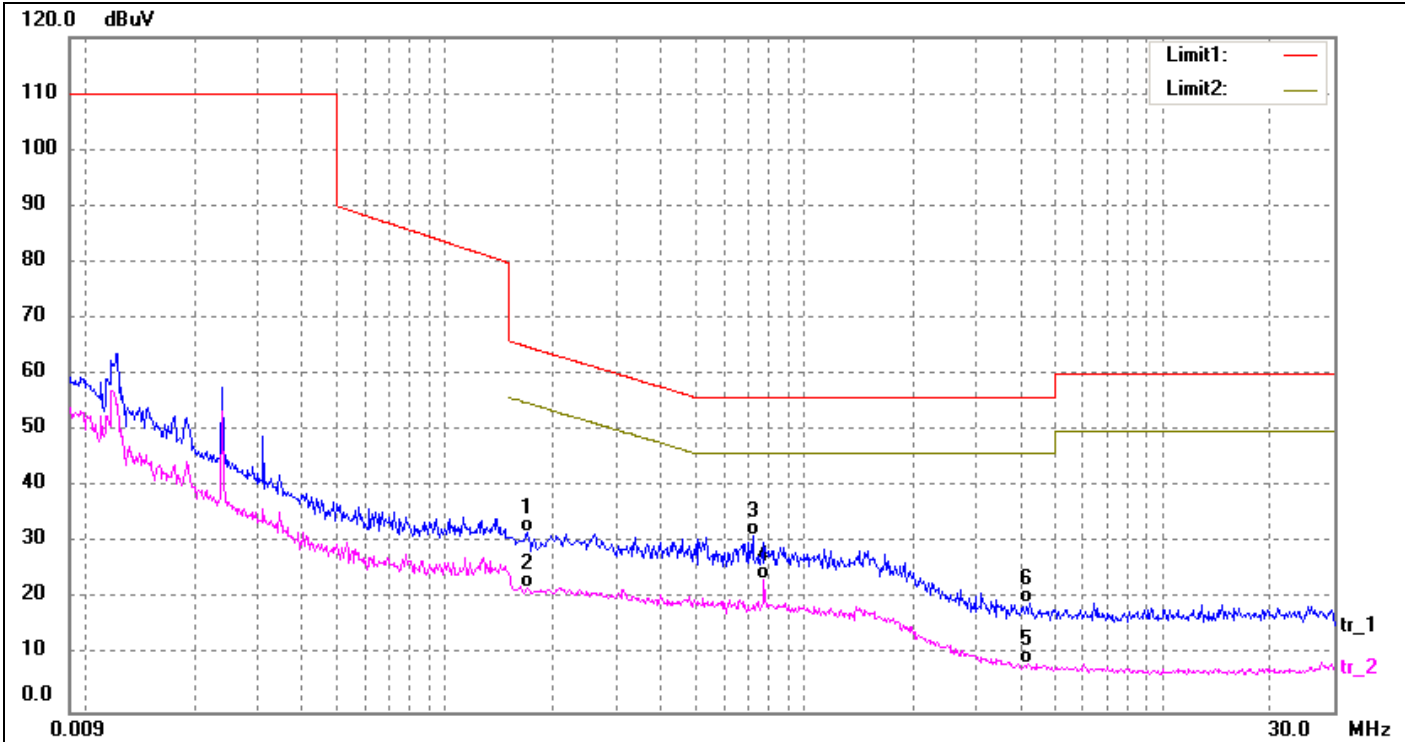

No.	Frequency (MHz)	Reading (dBuV)	Correct (dB)	Result (dBuV)	Limit (dBuV)	Over (dB)	Detector
1	0.1700	22.06	9.83	31.89	64.96	-33.07	QP
2	0.1700	12.32	9.83	22.15	54.96	-32.81	AVG
3	0.7220	21.49	9.78	31.27	56.00	-24.73	QP
4*	0.7780	13.74	9.78	23.52	46.00	-22.48	AVG
5	4.2260	-0.99	9.68	8.69	46.00	-37.31	AVG
6	4.2500	9.58	9.68	19.26	56.00	-36.74	QP

Model R50-6-30/A115/19-8 test data

Job No.:	CE	Phase:	L1
Standard:	EN55015 Conduction(QP)	Power Source:	AC 230V/50Hz
Test item:	Conduction Test	Date:	2017/09/06
Temp.(°C)/Hum.(%RH):	26°C/60%RH	Time:	16:31:12
Note:			

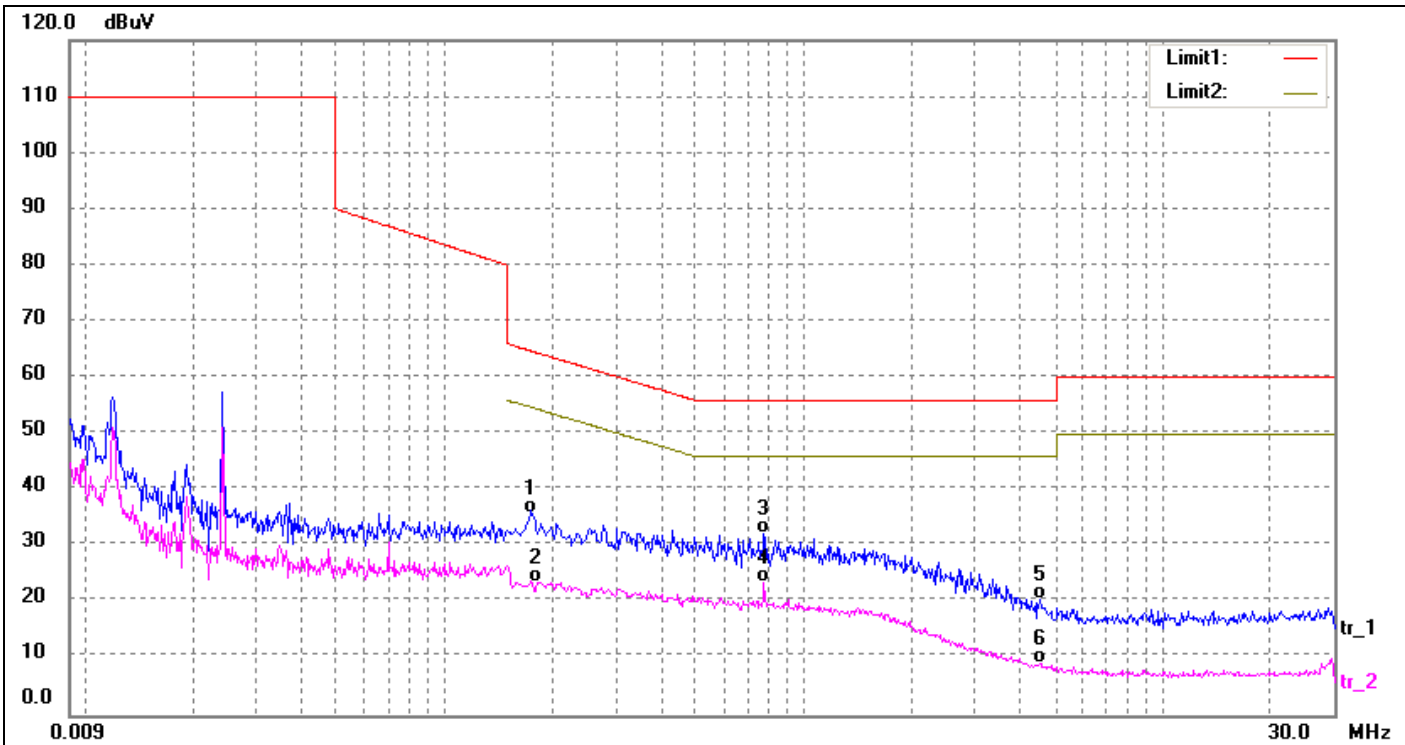

No.	Frequency (MHz)	Reading (dBuV)	Correct (dB)	Result (dBuV)	Limit (dBuV)	Over (dB)	Detector
1	0.1752	26.05	9.82	35.87	64.71	-28.84	QP
2	0.1820	13.84	9.82	23.66	54.39	-30.73	AVG
3	0.7780	22.53	9.78	32.31	56.00	-23.69	QP
4*	0.7780	13.73	9.78	23.51	46.00	-22.49	AVG
5	4.5500	10.88	9.67	20.55	56.00	-35.45	QP
6	4.5500	-0.50	9.67	9.17	46.00	-36.83	AVG

Job No.:	CE	Phase:	N
Standard:	EN55015 Conduction(QP)	Power Source:	AC 230V/50Hz
Test item:	Conduction Test	Date:	2017/09/06
Temp.(°C)/Hum.(%RH):	26°C/60%RH	Time:	16:26:07
Note:			

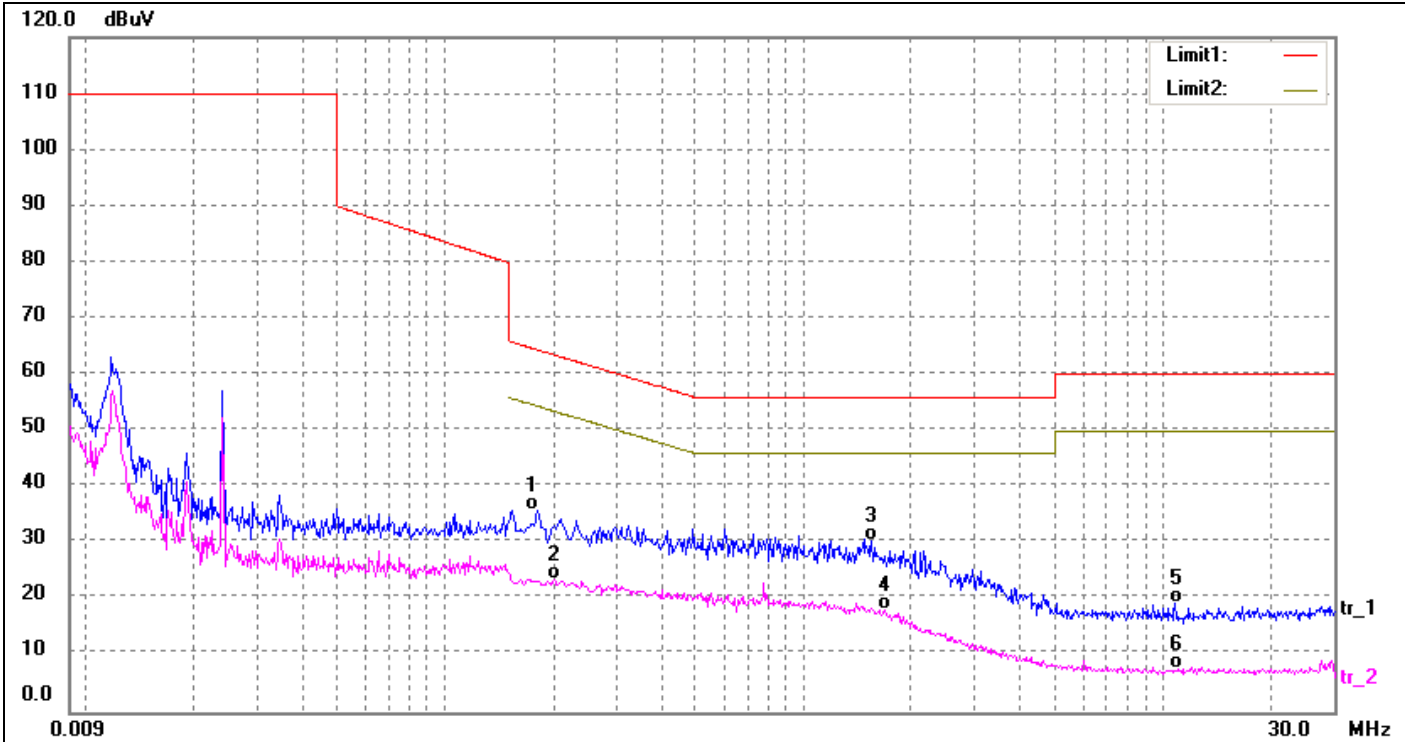

No.	Frequency (MHz)	Reading (dBuV)	Correct (dB)	Result (dBuV)	Limit (dBuV)	Over (dB)	Detector
1	0.1820	25.96	9.82	35.78	64.39	-28.61	QP
2	0.2020	13.77	9.80	23.57	53.53	-29.96	AVG
3*	1.5500	20.70	9.75	30.45	56.00	-25.55	QP
4	1.6780	8.30	9.74	18.04	46.00	-27.96	AVG
5	10.8180	9.70	9.53	19.23	60.00	-40.77	QP
6	11.0500	-1.87	9.54	7.67	50.00	-42.33	AVG

Model R63-6-XX/A125/19-8 test data

Job No.:	CE	Phase:	L1
Standard:	EN55015 Conduction(QP)	Power Source:	AC 230V/50Hz
Test item:	Conduction Test	Date:	2017/09/06
Temp.(°C)/Hum.(%RH):	26°C/60%RH	Time:	16:13:53
Note:			

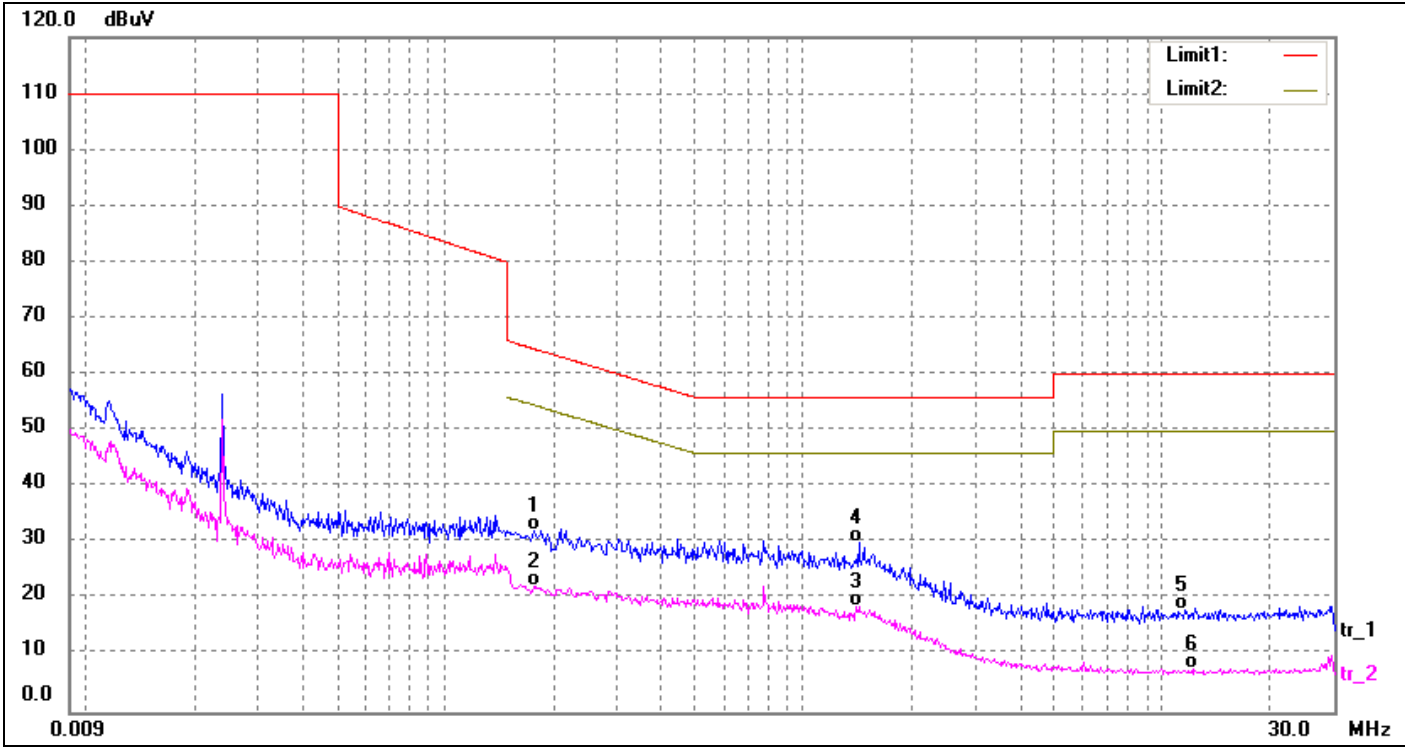

No.	Frequency (MHz)	Reading (dBuV)	Correct (dB)	Result (dBuV)	Limit (dBuV)	Over (dB)	Detector
1	0.1780	22.34	9.82	32.16	64.58	-32.42	QP
2	0.1780	12.43	9.82	22.25	54.58	-32.33	AVG
3	1.4060	8.89	9.75	18.64	46.00	-27.36	AVG
4*	1.4300	20.49	9.75	30.24	56.00	-25.76	QP
5	11.5580	8.51	9.55	18.06	60.00	-41.94	QP
6	12.1380	-1.90	9.56	7.66	50.00	-42.34	AVG

Job No.:	CE	Phase:	N
Standard:	EN55015 Conduction(QP)	Power Source:	AC 230V/50Hz
Test item:	Conduction Test	Date:	2017/09/06
Temp.(°C)/Hum.(%RH):	26°C/60%RH	Time:	16:19:31
Note:			

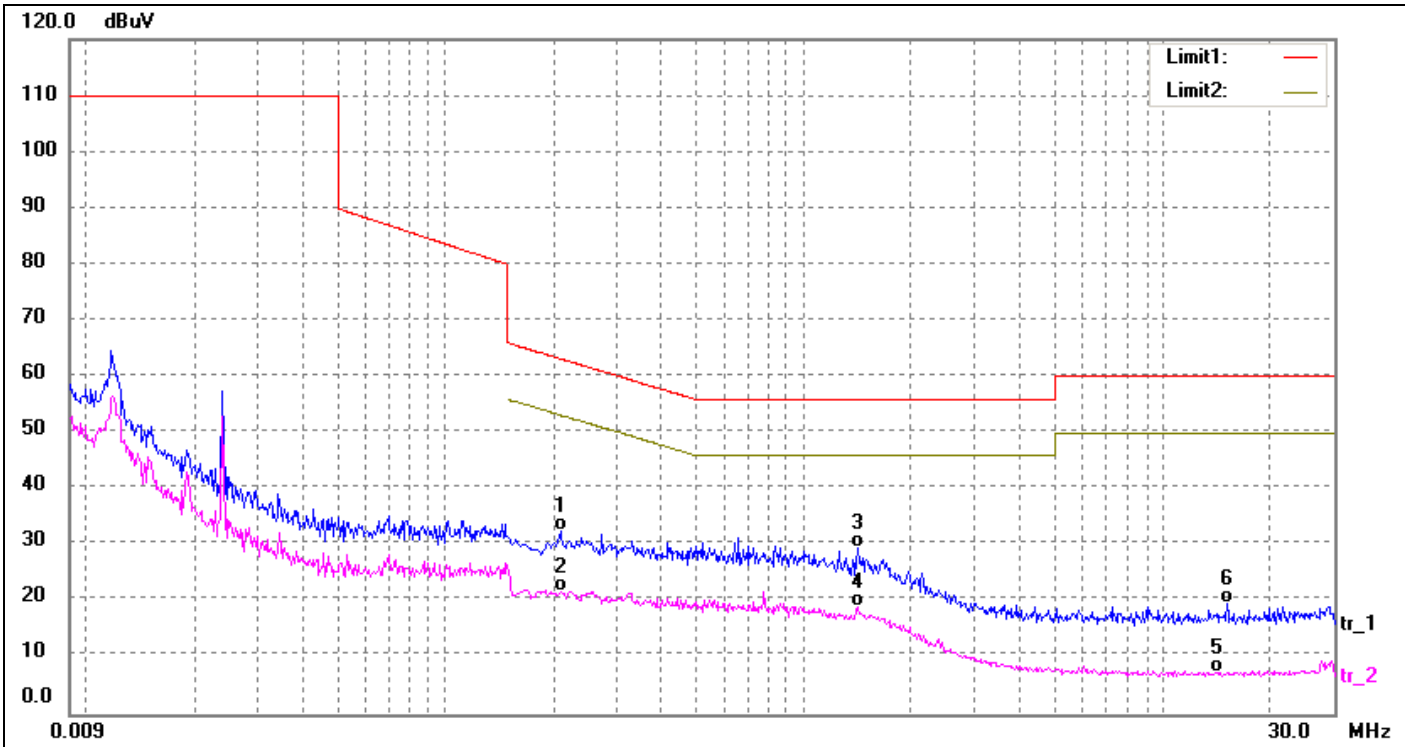

No.	Frequency (MHz)	Reading (dBuV)	Correct (dB)	Result (dBuV)	Limit (dBuV)	Over (dB)	Detector
1	0.2100	22.81	9.80	32.61	63.21	-30.60	QP
2	0.2100	11.92	9.80	21.72	53.20	-31.48	AVG
3*	1.4180	19.70	9.75	29.45	56.00	-26.55	QP
4	1.4180	9.43	9.75	19.18	46.00	-26.82	AVG
5	14.2700	-2.13	9.60	7.47	50.00	-42.53	AVG
6	15.1220	9.98	9.61	19.59	60.00	-40.41	QP

4.2 Radiated electromagnetic disturbances

This clause lays down the general requirements for the magnetic component of the radiated disturbance field strength in the frequency range 9 kHz to 30 MHz

4.2.1 limits

Frequency range Hz	Limits for loop diameter dB (μ A)
	2 m
9 kHz to 70 kHz	88
70 kHz to 150 kHz	88 to 58
150 kHz to 3 MHz	58 to 22
3 MHz to 30 MHz	22

Note: At the transition frequency, the lower limit applies.
Decreasing linearly with the logarithm of the frequency.
Increasing linearly with the logarithm of the frequency.

4.2.2 Measurement procedure

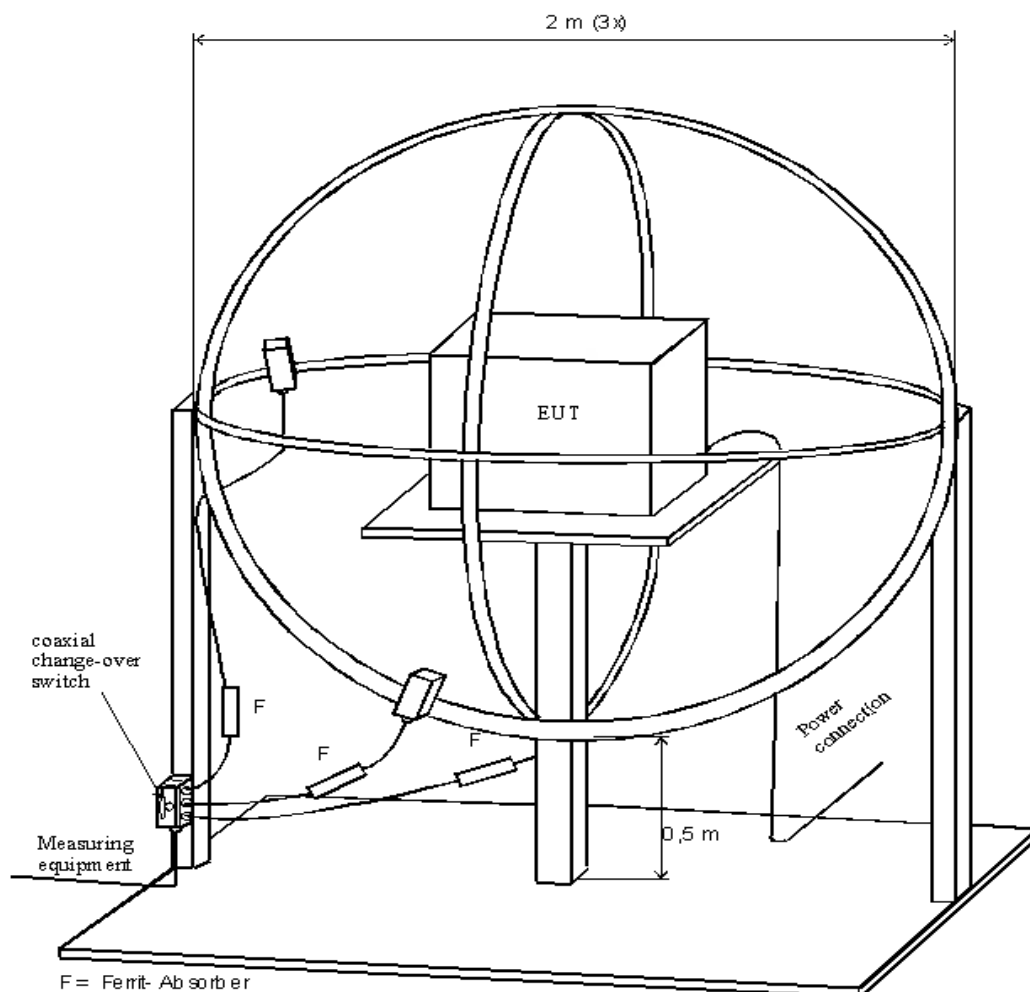

Test Report No.: EFSH17090053-IE-01-E01

Eurofins Product Testing Service (Shanghai) Co., Ltd
No. 395 West Jiangchang Road, Jing'an District, Shanghai, China



The EUT is placed in the centre of the loop antenna system. The current induced by the magnetic field from the EUT into each of the three large loop antennas of the loop antenna system is measured by connecting the current probe of the large loop antenna to a measuring receiver. During the measurements the EUT remains in a fixed position. Before get the final emission results with quasi-peak (QP) detector, a pre-scan was performed with the peak (PK) to find out the maximum emission data plots of the EUT.

Test Report No.: EFSH17090053-IE-01-E01

Eurofins Product Testing Service (Shanghai) Co., Ltd
No. 395 West Jiangchang Road, Jing'an District, Shanghai, China

4.2.3 Results

Model GU10-6-30/K157/24 test data X direction Test Result

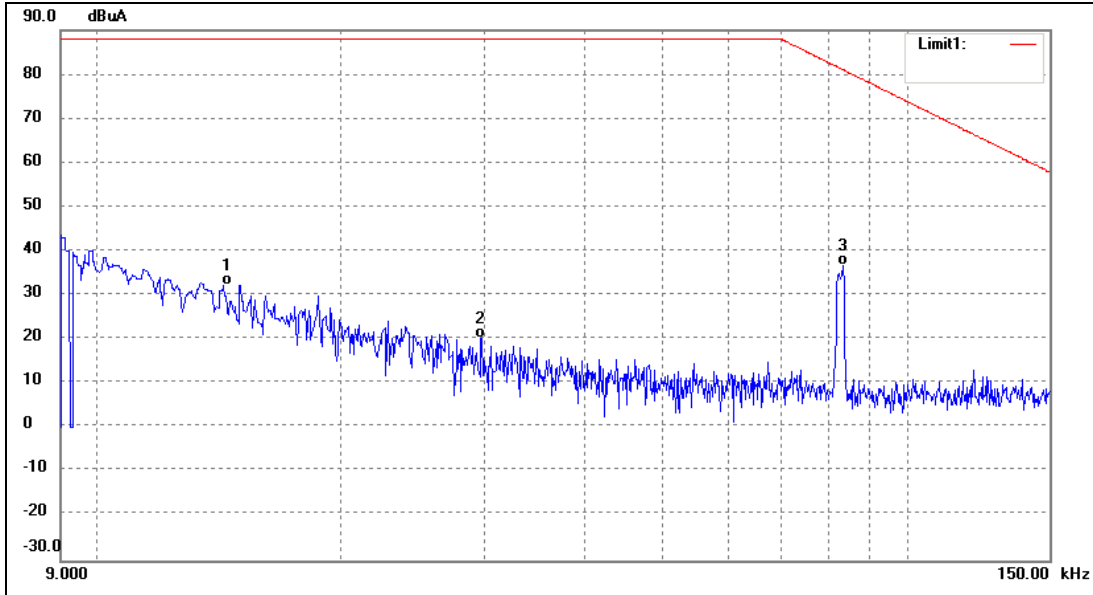

No.	Frequency (KHz)	Reading (dBuA)	Correct (dB)	Result (dBuA)	Limit (dBuA)	Over (dB)	Detector
1	0.0144	-3.79	36.14	32.35	88.00	-55.65	QP
2	0.0298	-8.61	28.98	20.37	88.00	-67.63	QP
3*	0.0834	14.64	22.06	36.70	81.10	-44.40	QP

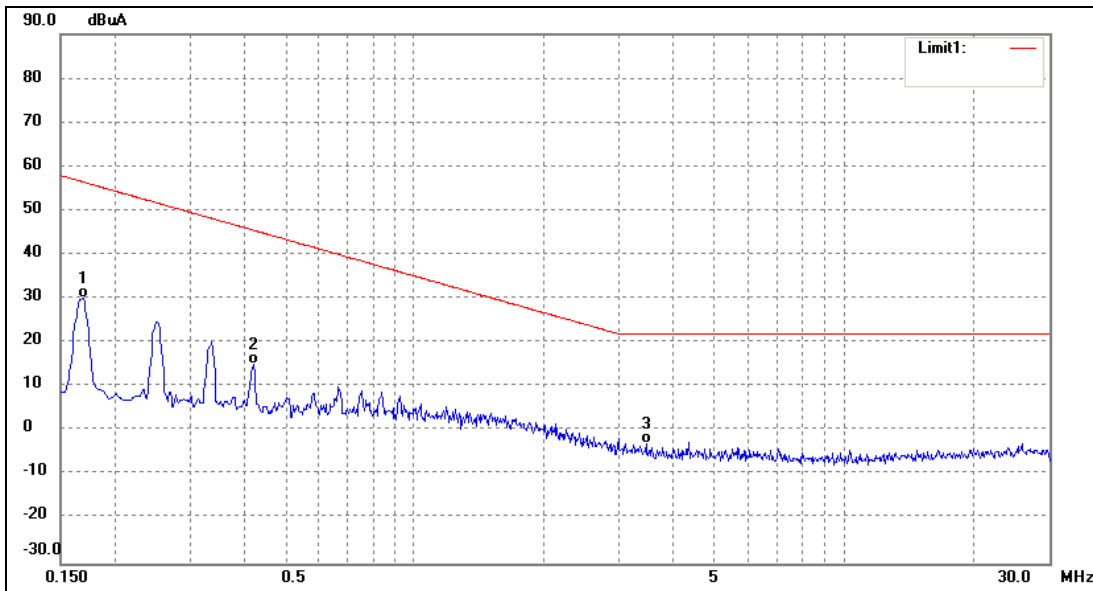

No.	Frequency (MHz)	Reading (dBuA)	Correct (dB)	Result (dBuA)	Limit (dBuA)	Over (dB)	Detector
1	0.1700	9.14	20.93	30.07	56.50	-26.43	QP
2	0.4220	-5.31	20.34	15.03	45.57	-30.54	QP
3*	3.4660	-23.59	20.63	-2.96	22.00	-24.96	QP

Test Report No.: EFSH17090053-IE-01-E01

Eurofins Product Testing Service (Shanghai) Co., Ltd
No. 395 West Jiangchang Road, Jing'an District, Shanghai, China

Y direction Test Result

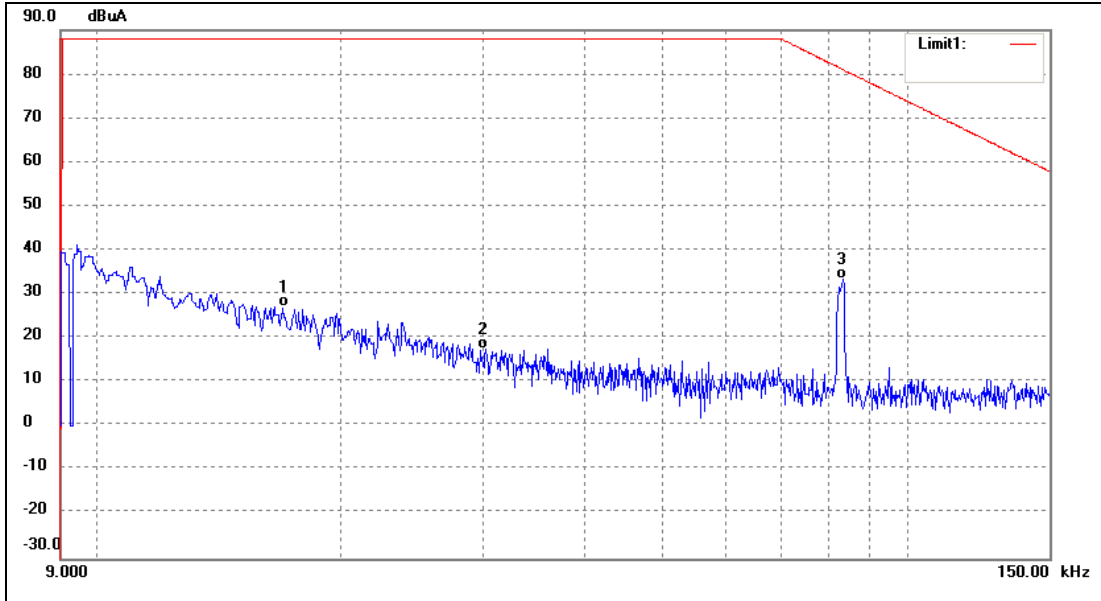

No.	Frequency (KHz)	Reading (dBuA)	Correct (dB)	Result (dBuA)	Limit (dBuA)	Over (dB)	Detector
1	0.0165	-6.44	33.67	27.23	88.00	-60.77	QP
2	0.0302	-10.56	27.99	17.43	88.00	-70.57	QP
3*	0.0836	11.79	21.57	33.36	81.01	-47.65	QP

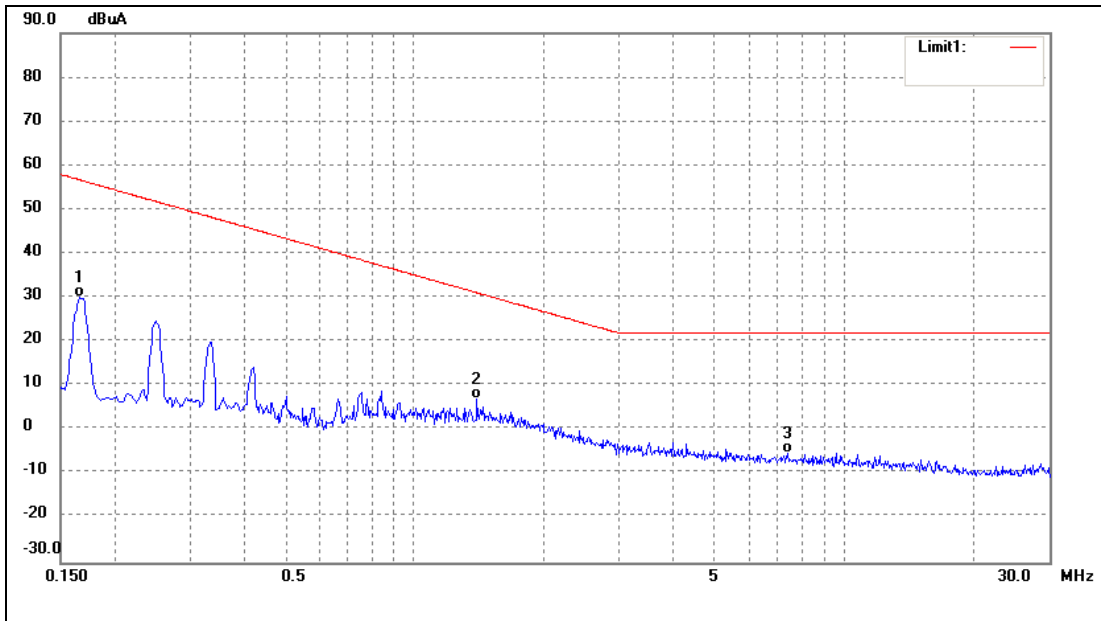

No.	Frequency (MHz)	Reading (dBuA)	Correct (dB)	Result (dBuA)	Limit (dBuA)	Over (dB)	Detector
1	0.1660	9.39	20.63	30.02	56.77	-26.75	QP
2*	1.4020	-13.05	19.96	6.91	31.14	-24.23	QP
3	7.3900	-25.02	19.91	-5.11	22.00	-27.11	QP

Test Report No.: EFSH17090053-IE-01-E01

Eurofins Product Testing Service (Shanghai) Co., Ltd
No. 395 West Jiangchang Road, Jing'an District, Shanghai, China

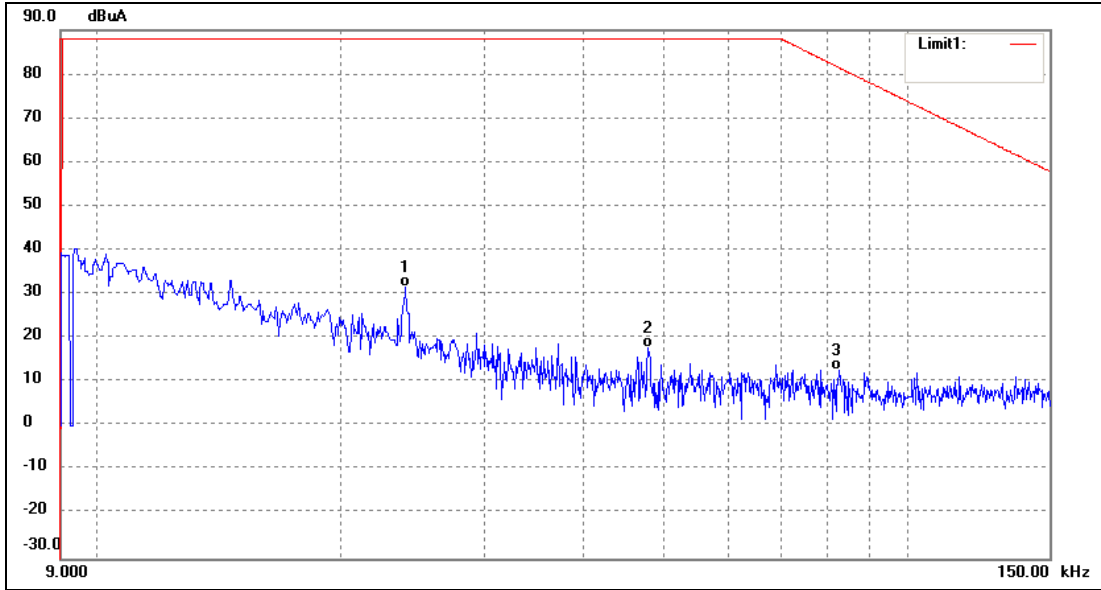
Z direction Test Result

No.	Frequency (KHz)	Reading (dBuA)	Correct (dB)	Result (dBuA)	Limit (dBuA)	Over (dB)	Detector
1*	0.0240	1.22	30.46	31.68	88.00	-56.32	QP
2	0.0480	-6.09	23.98	17.89	88.00	-70.11	QP
3	0.0825	-8.92	21.70	12.78	81.53	-68.75	QP

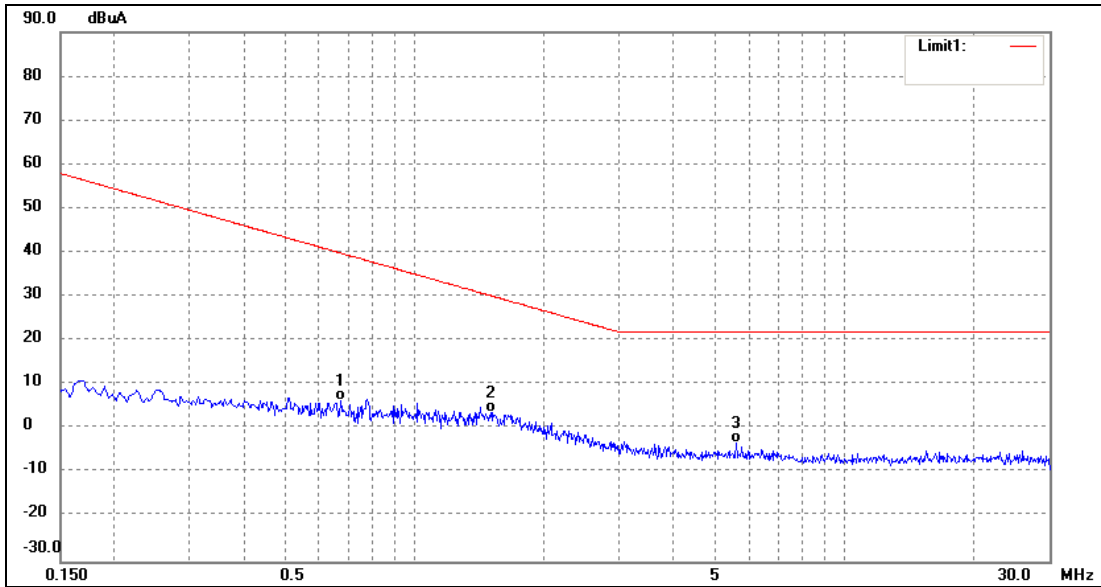

No.	Frequency (MHz)	Reading (dBuA)	Correct (dB)	Result (dBuA)	Limit (dBuA)	Over (dB)	Detector
1	0.6740	-13.42	19.82	6.40	39.94	-33.54	QP
2	1.5060	-16.11	20.01	3.90	30.28	-26.38	QP
3*	5.5980	-23.55	20.36	-3.19	22.00	-25.19	QP

Test Report No.: EFSH17090053-IE-01-E01

Eurofins Product Testing Service (Shanghai) Co., Ltd
No. 395 West Jiangchang Road, Jing'an District, Shanghai, China

X direction Test Result

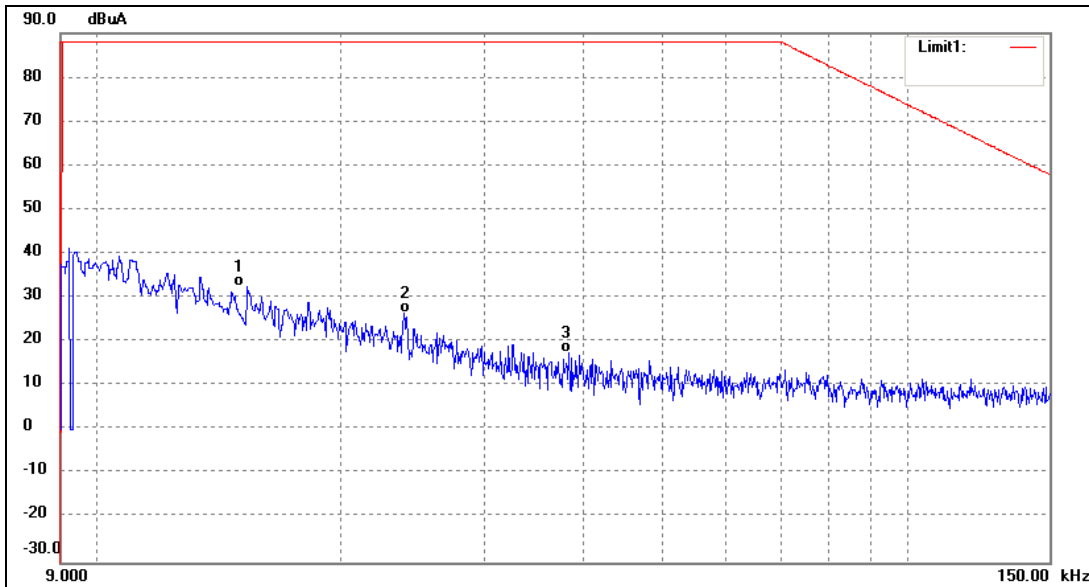

No.	Frequency (KHz)	Reading (dBuA)	Correct (dB)	Result (dBuA)	Limit (dBuA)	Over (dB)	Detector
1*	0.0153	-3.04	35.57	32.53	88.00	-55.47	QP
2	0.0240	-4.56	31.10	26.54	88.00	-61.46	QP
3	0.0383	-8.22	25.88	17.66	88.00	-70.34	QP

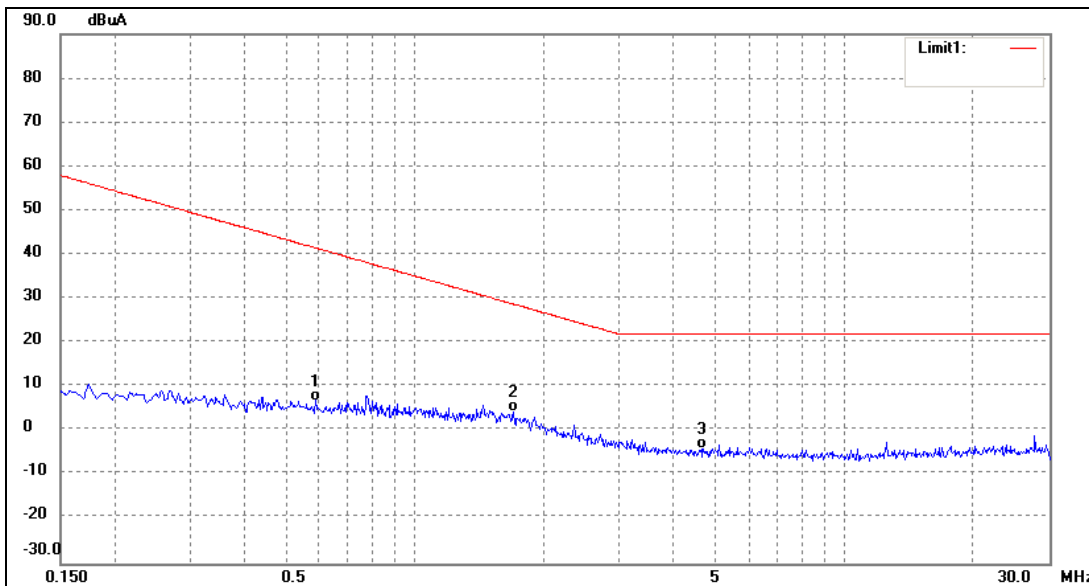

No.	Frequency (MHz)	Reading (dBuA)	Correct (dB)	Result (dBuA)	Limit (dBuA)	Over (dB)	Detector
1	0.5899	-13.27	20.17	6.90	41.54	-34.64	QP
2*	1.7020	-15.97	20.41	4.44	28.81	-24.37	QP
3	4.6700	-24.62	20.69	-3.93	22.00	-25.93	QP

Y direction Test Result

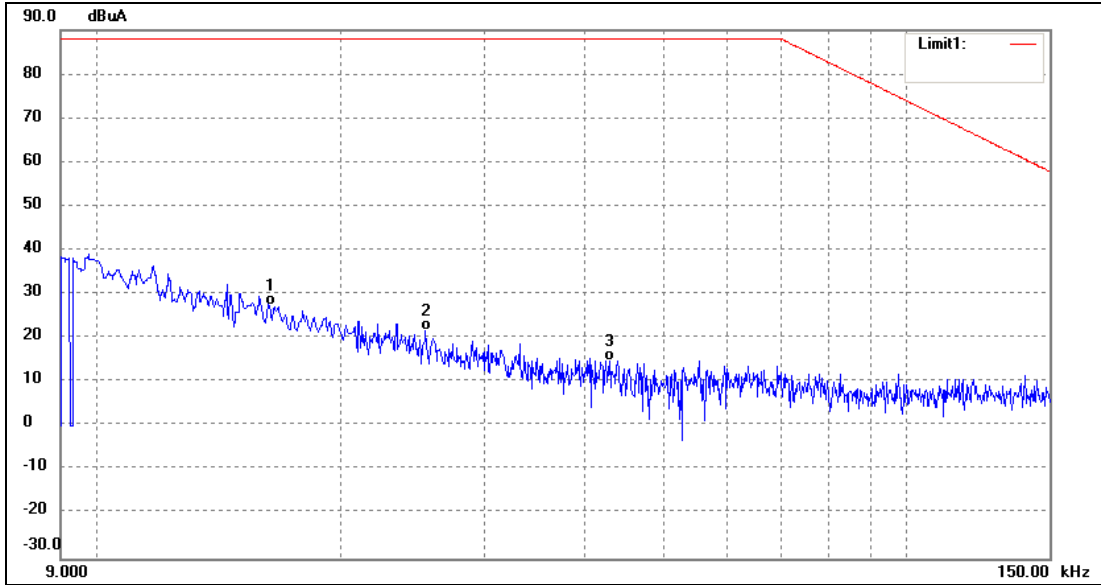

No.	Frequency (KHz)	Reading (dBuA)	Correct (dB)	Result (dBuA)	Limit (dBuA)	Over (dB)	Detector
1*	0.0163	-6.27	33.79	27.52	88.00	-60.48	QP
2	0.0255	-7.88	29.63	21.75	88.00	-66.25	QP
3	0.0429	-9.41	24.40	14.99	88.00	-73.01	QP

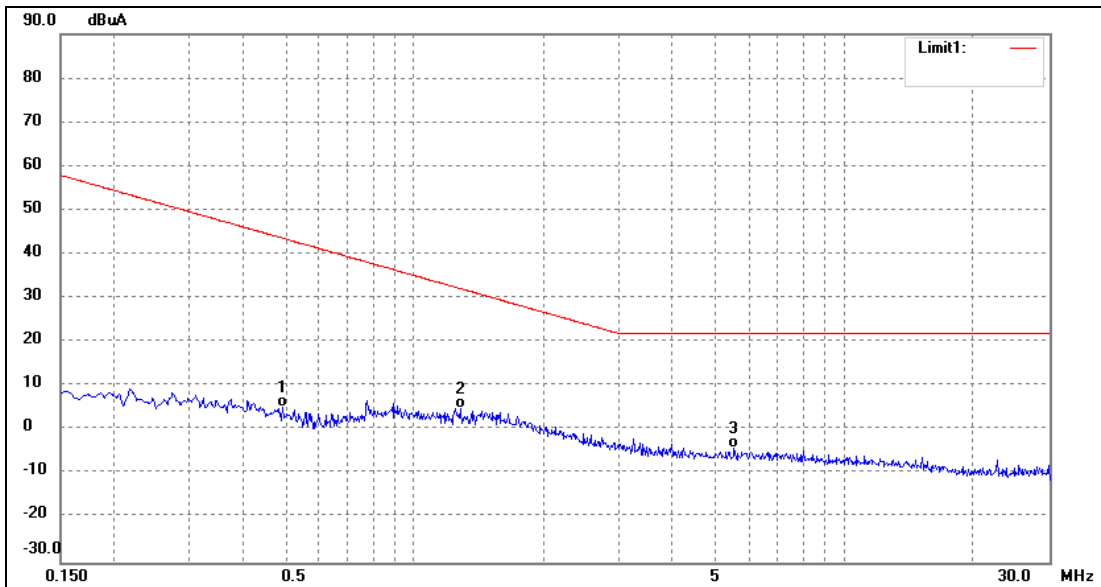

No.	Frequency (MHz)	Reading (dBuA)	Correct (dB)	Result (dBuA)	Limit (dBuA)	Over (dB)	Detector
1	0.4940	-13.20	18.56	5.36	43.68	-38.32	QP
2	1.2780	-15.06	19.90	4.84	32.25	-27.41	QP
3*	5.5460	-24.40	20.28	-4.12	22.00	-26.12	QP

Test Report No.: EFSH17090053-IE-01-E01

Eurofins Product Testing Service (Shanghai) Co., Ltd
No. 395 West Jiangchang Road, Jing'an District, Shanghai, China

Z direction Test Result

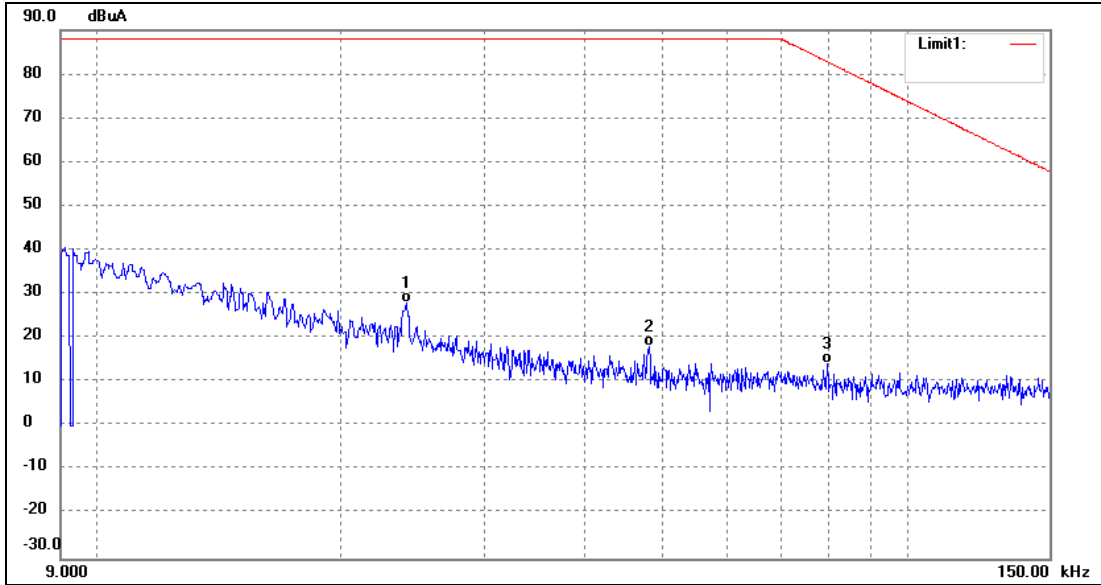

No.	Frequency (KHz)	Reading (dBuA)	Correct (dB)	Result (dBuA)	Limit (dBuA)	Over (dB)	Detector
1*	0.0241	-2.48	30.42	27.94	88.00	-60.06	QP
2	0.0480	-5.81	23.98	18.17	88.00	-69.83	QP
3	0.0798	-7.65	21.77	14.12	82.84	-68.72	QP

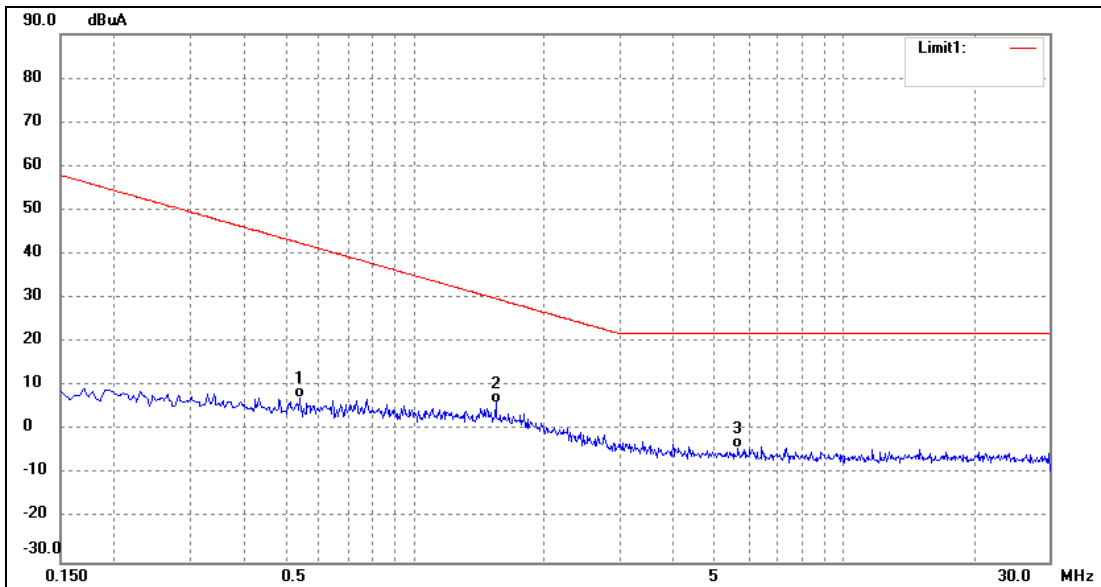

No.	Frequency (MHz)	Reading (dBuA)	Correct (dB)	Result (dBuA)	Limit (dBuA)	Over (dB)	Detector
1	0.5420	-12.60	19.83	7.23	42.56	-35.33	QP
2*	1.5500	-13.74	20.04	6.30	29.93	-23.63	QP
3	5.6540	-24.49	20.36	-4.13	22.00	-26.13	QP

Test Report No.: EFSH17090053-IE-01-E01

Eurofins Product Testing Service (Shanghai) Co., Ltd
No. 395 West Jiangchang Road, Jing'an District, Shanghai, China

X direction Test Result

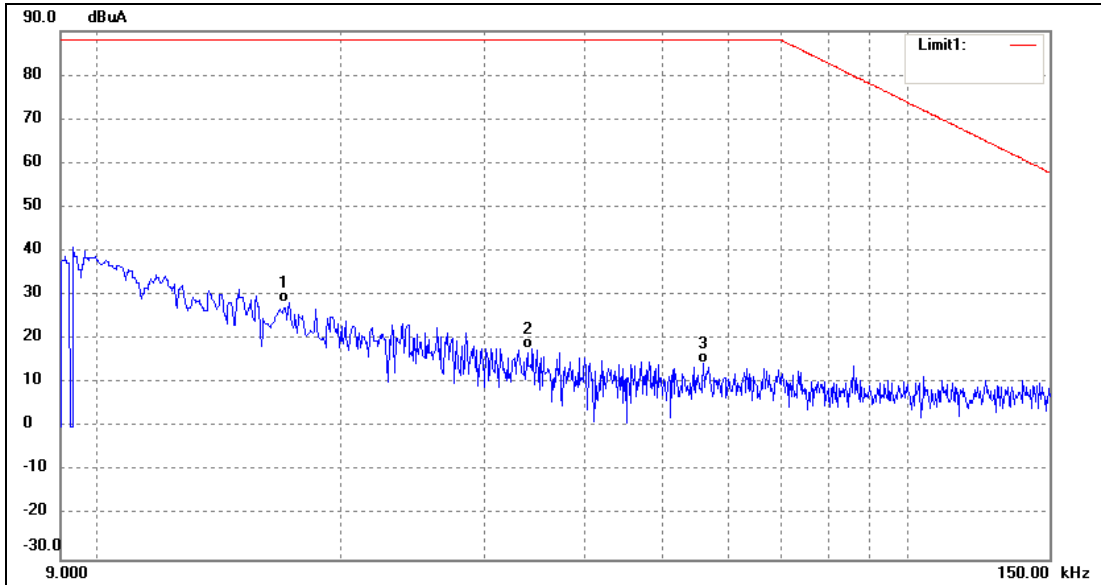

No.	Frequency (KHz)	Reading (dBuA)	Correct (dB)	Result (dBuA)	Limit (dBuA)	Over (dB)	Detector
1*	0.0171	-5.94	34.42	28.48	88.00	-59.52	QP
2	0.0343	-9.46	27.34	17.88	88.00	-70.12	QP
3	0.0562	-8.98	23.47	14.49	88.00	-73.51	QP

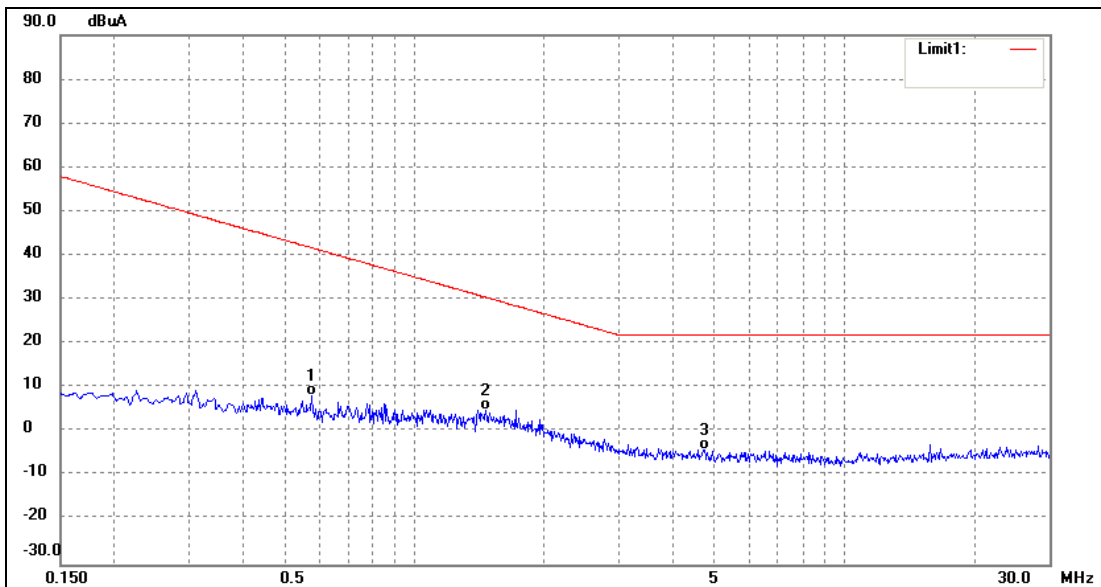

No.	Frequency (MHz)	Reading (dBuA)	Correct (dB)	Result (dBuA)	Limit (dBuA)	Over (dB)	Detector
1	0.5780	-11.84	20.18	8.34	41.79	-33.45	QP
2*	1.4700	-15.25	20.29	5.04	30.57	-25.53	QP
3	4.7260	-24.75	20.70	-4.05	22.00	-26.05	QP

Y direction Test Result

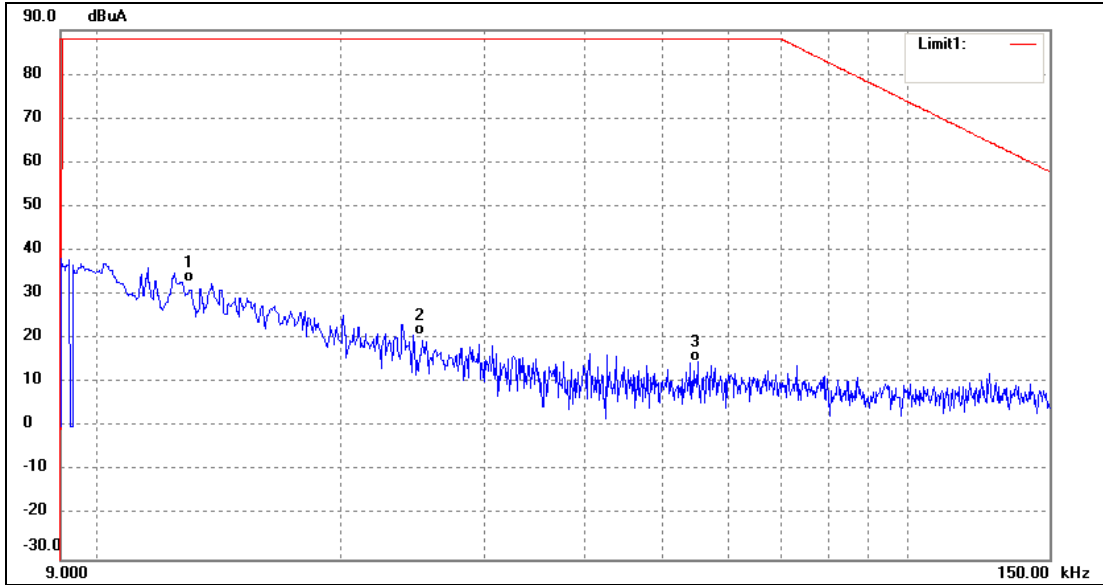

No.	Frequency (KHz)	Reading (dBuA)	Correct (dB)	Result (dBuA)	Limit (dBuA)	Over (dB)	Detector
1*	0.0128	-3.08	35.91	32.83	88.00	-55.17	QP
2	0.0245	-9.15	29.98	20.83	88.00	-67.17	QP
3	0.0552	-8.92	23.72	14.80	88.00	-73.20	QP

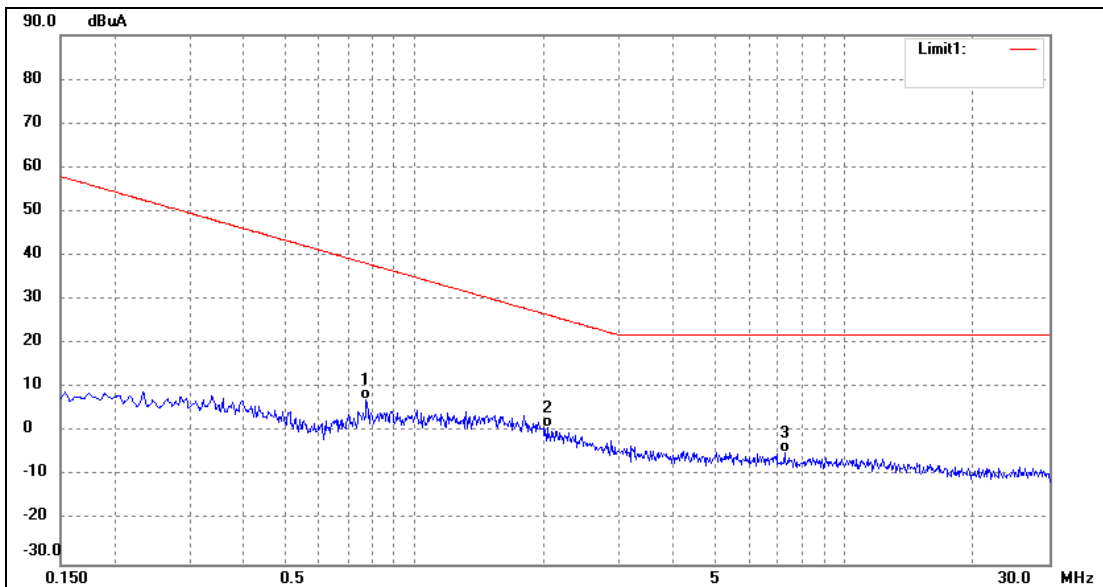

No.	Frequency (MHz)	Reading (dBuA)	Correct (dB)	Result (dBuA)	Limit (dBuA)	Over (dB)	Detector
1	0.7740	-11.95	19.38	7.43	38.28	-30.85	QP
2*	2.0340	-19.23	20.26	1.03	26.67	-25.64	QP
3	7.2700	-24.60	19.94	-4.66	22.00	-26.66	QP

Test Report No.: EFSH17090053-IE-01-E01

Eurofins Product Testing Service (Shanghai) Co., Ltd
 No. 395 West Jiangchang Road, Jing'an District, Shanghai, China

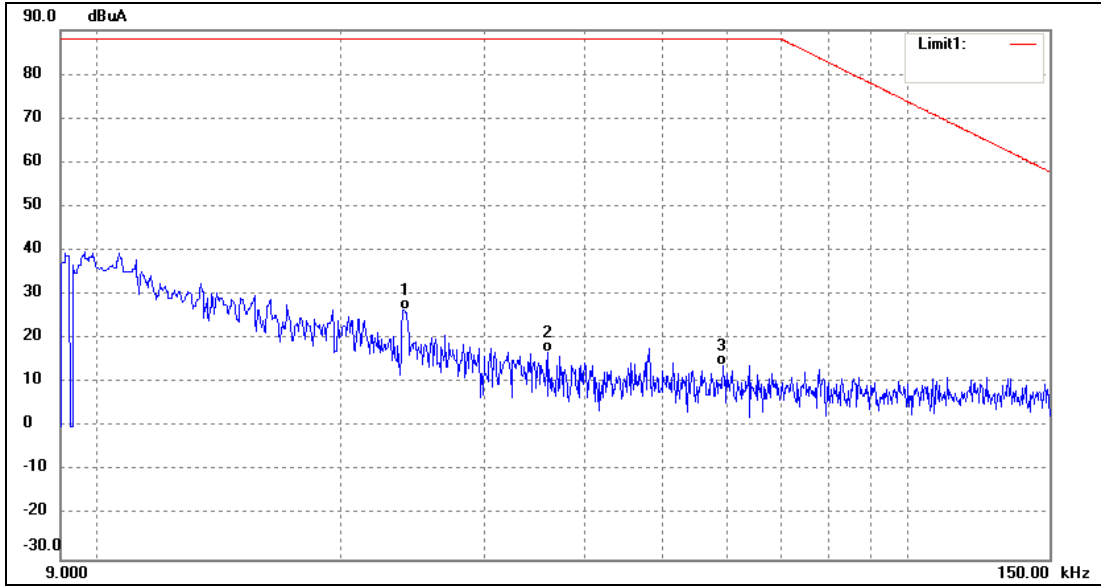
Z direction Test Result

No.	Frequency (KHz)	Reading (dBuA)	Correct (dB)	Result (dBuA)	Limit (dBuA)	Over (dB)	Detector
1*	0.0240	-3.76	30.46	26.70	88.00	-61.30	QP
2	0.0360	-9.45	26.26	16.81	88.00	-71.19	QP
3	0.0594	-8.88	22.72	13.84	88.00	-74.16	QP

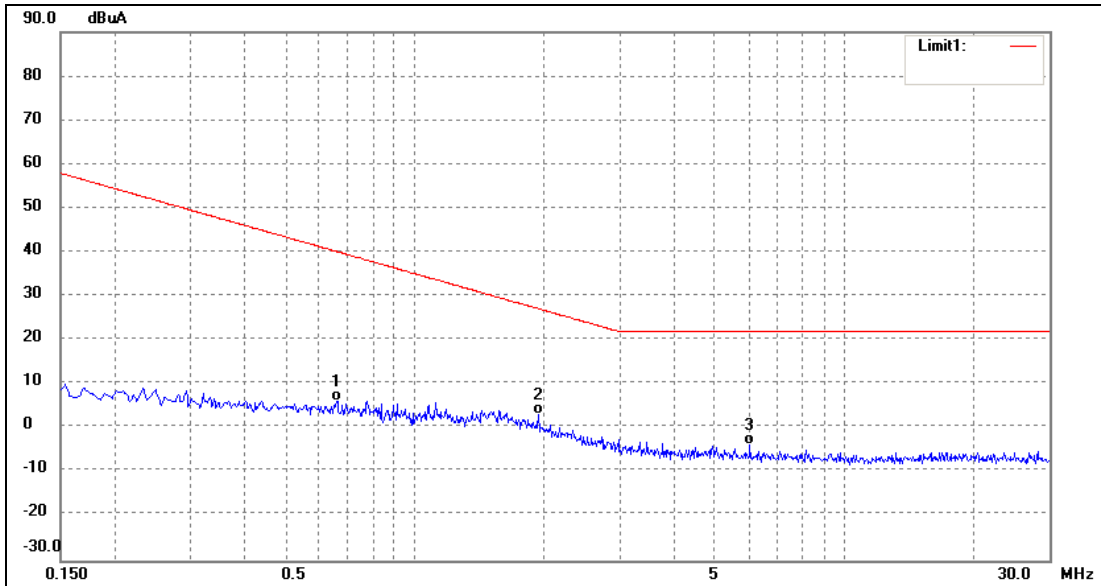

No.	Frequency (MHz)	Reading (dBuA)	Correct (dB)	Result (dBuA)	Limit (dBuA)	Over (dB)	Detector
1	0.6580	-13.81	19.83	6.02	40.23	-34.21	QP
2*	1.9460	-17.15	20.23	3.08	27.20	-24.12	QP
3	6.0300	-24.15	20.35	-3.80	22.00	-25.80	QP

X direction Test Result

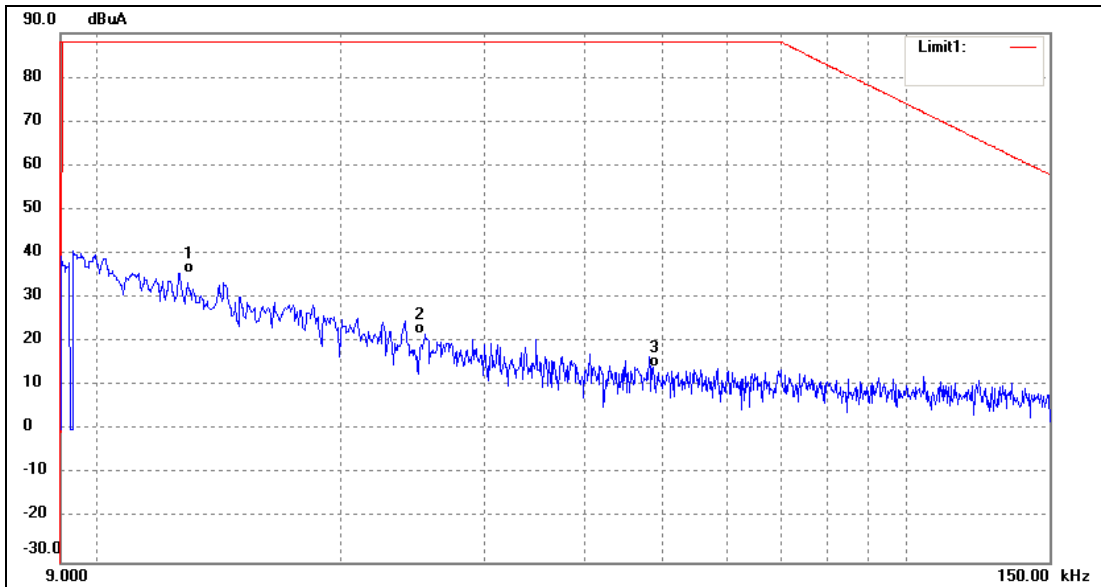

No.	Frequency (KHz)	Reading (dBuA)	Correct (dB)	Result (dBuA)	Limit (dBuA)	Over (dB)	Detector
1*	0.0126	-1.85	37.30	35.45	88.00	-52.55	QP
2	0.0254	-8.88	30.59	21.71	88.00	-66.29	QP
3	0.0487	-9.92	24.30	14.38	88.00	-73.62	QP

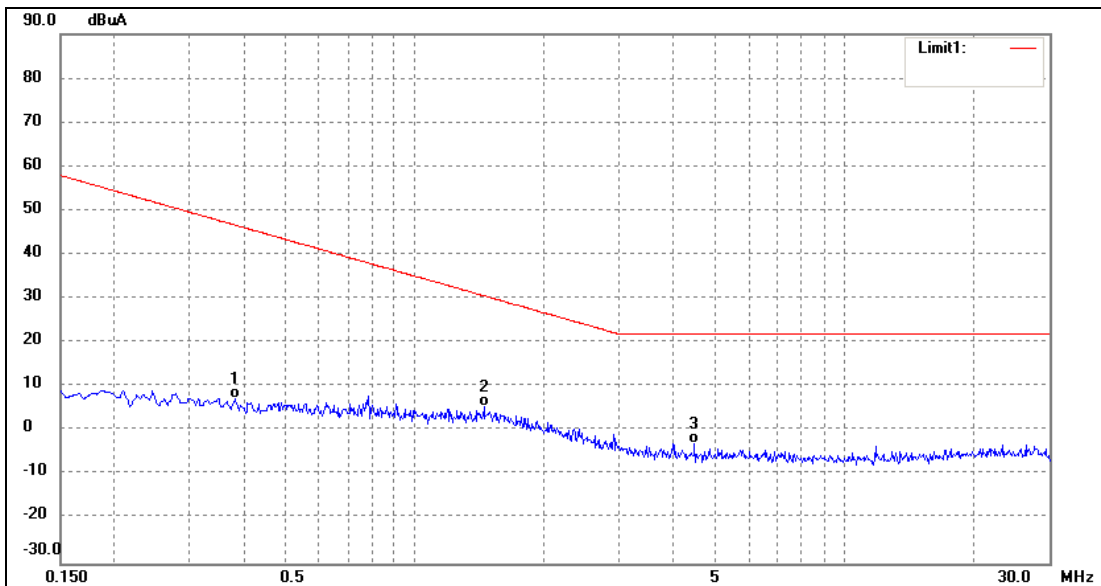

No.	Frequency (MHz)	Reading (dBuA)	Correct (dB)	Result (dBuA)	Limit (dBuA)	Over (dB)	Detector
1	0.3820	-12.97	20.39	7.42	46.77	-39.35	QP
2	1.4500	-14.84	20.29	5.45	30.74	-25.29	QP
3*	4.4980	-23.66	20.68	-2.98	22.00	-24.98	QP

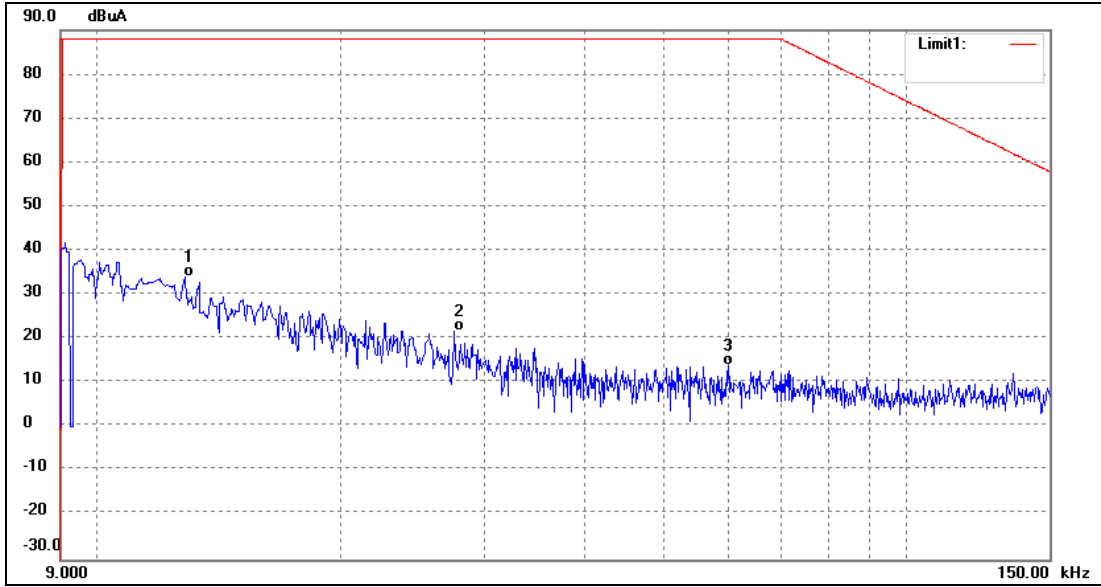
Y direction Test Result

No.	Frequency (KHz)	Reading (dBuA)	Correct (dB)	Result (dBuA)	Limit (dBuA)	Over (dB)	Detector
1*	0.0128	-1.97	35.91	33.94	88.00	-54.06	QP
2	0.0276	-7.13	28.90	21.77	88.00	-66.23	QP
3	0.0601	-9.49	23.45	13.96	88.00	-74.04	QP

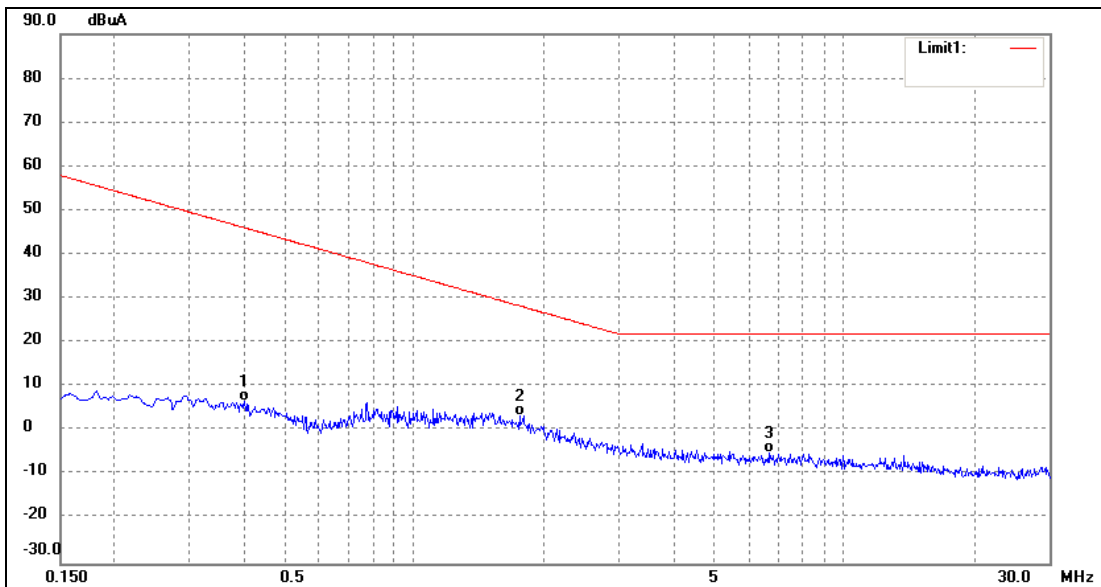

No.	Frequency (MHz)	Reading (dBuA)	Correct (dB)	Result (dBuA)	Limit (dBuA)	Over (dB)	Detector
1	0.4020	-13.36	20.03	6.67	46.15	-39.48	QP
2*	1.7620	-16.72	20.14	3.42	28.40	-24.98	QP
3	6.6860	-25.01	20.09	-4.92	22.00	-26.92	QP

Test Report No.: EFSH17090053-IE-01-E01

Eurofins Product Testing Service (Shanghai) Co., Ltd
 No. 395 West Jiangchang Road, Jing'an District, Shanghai, China

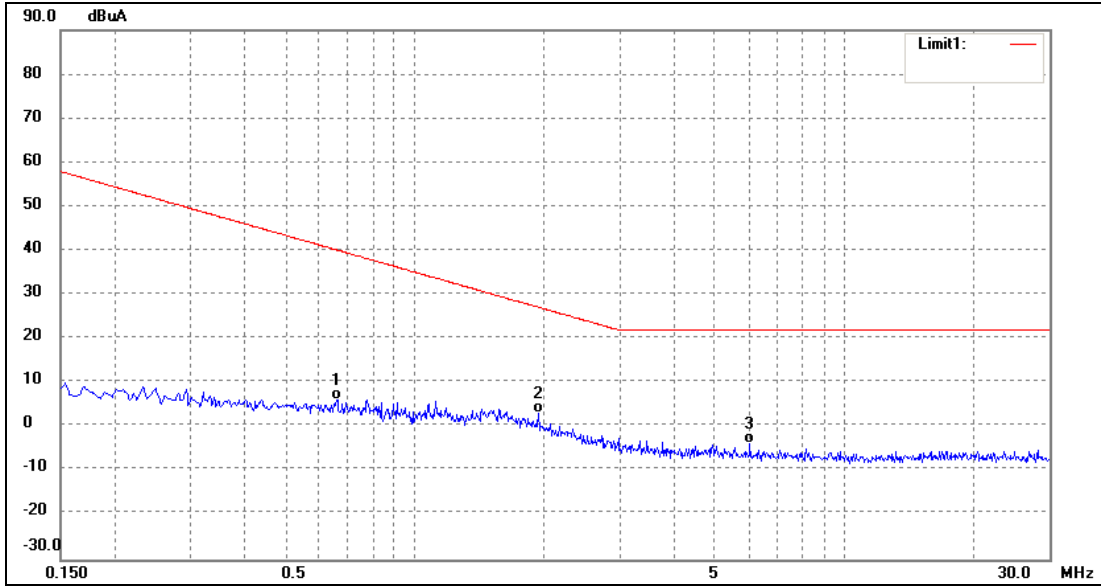
Z direction Test Result

No.	Frequency (MHz)	Reading (dBuA)	Correct (dB/m)	Result (dBuA)	Limit (dBuA)	Over (dB)	Detector
1	0.6580	-13.81	19.83	6.02	40.23	-34.21	QP
2*	1.9460	-17.15	20.23	3.08	27.20	-24.12	QP
3	6.0300	-24.15	20.35	-3.80	22.00	-25.80	QP

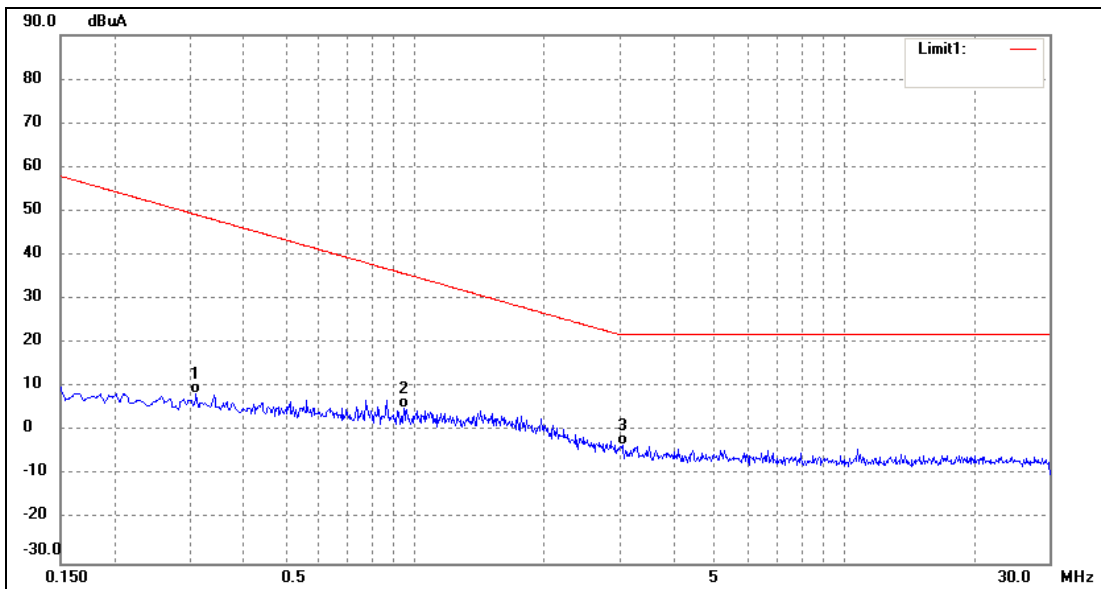

No.	Frequency (MHz)	Reading (dBuA)	Correct (dB)	Result (dBuA)	Limit (dBuA)	Over (dB)	Detector
1	0.3100	-11.56	20.03	8.47	49.28	-40.81	QP
2	0.9460	-14.37	19.76	5.39	35.87	-30.48	QP
3*	3.0500	-23.45	20.31	-3.14	22.00	-25.14	QP

Test Report No.: EFSH17090053-IE-01-E01

Eurofins Product Testing Service (Shanghai) Co., Ltd
 No. 395 West Jiangchang Road, Jing'an District, Shanghai, China

4.3 Radiated disturbance

This clause lays down the general requirements for the measurement of Radiated disturbance produced at the space of apparatus.

4.3.1 Limits

Frequency range	Quasi-peak limits at 10m	Quasi-peak limits at 3m
MHz	dB ($\mu\text{V}/\text{m}$)	dB ($\mu\text{V}/\text{m}$)
30 to 230	30	40
230 to 300	37	47

At transitional frequencies the lower limit applies.

4.3.2 Measurement procedure

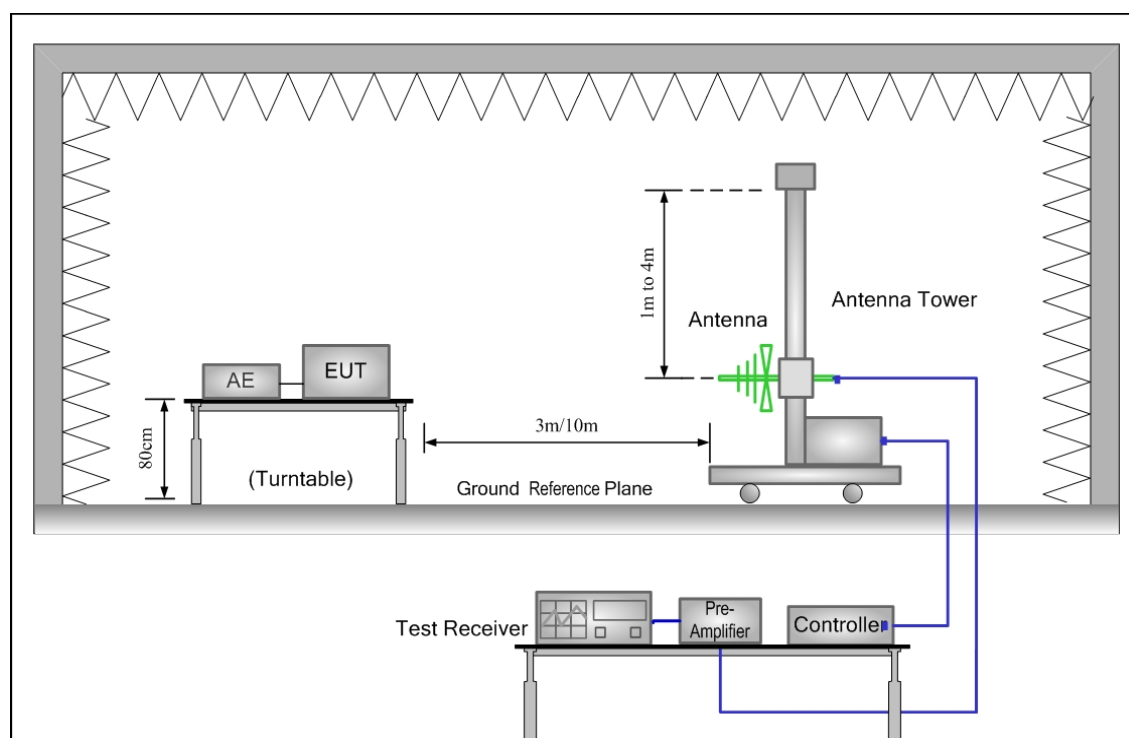

1. The radiated emissions test was conducted in a semi-anechoic chamber. The EUT was placed upon a non-metallic table 0.8m above the ground reference plane. And for floor-standing arrangement, the EUT was placed on the horizontal ground reference plane, but separated from metallic contact with the ground reference plane by 0.1m of insulation.
2. Before get the final emission results with quasi-peak(QP) detector, a pre-scan was performed with the peak(PK) detector to find out the maximum emission data plots of the EUT.
3. The frequencies of maximum emission were determined in the final radiated emissions measurement, the physical arrangement of the test system and associated cabling was varied in order to determine the effect on the EUT's emissions in amplitude, direction and frequency. At each frequency, the EUT was rotated 360°, and the antenna was raised and lowered from 1 to 4 meters in order to determine the maximum disturbance. Measurements were performed for both horizontal and vertical antenna polarization. Test was performed on subcontractor at 3 m distance.

4.3.3 Measurement uncertainty

U_{lab}(cond) = 3.9dB at 95% level of confidence, k=2

4.3.4 Results

Model GU10-6-30/K157/24 test data

Job No.:	RE	Polarization:	Horizontal
Standard:	EN55015	Power Source:	AC 230V/50Hz
Test item:	Radiation Test	Date:	17/09/08/
Temp.(C)/Hum.(%RH):	22(C)/54%RH	Time:	14/38/38
Note:			

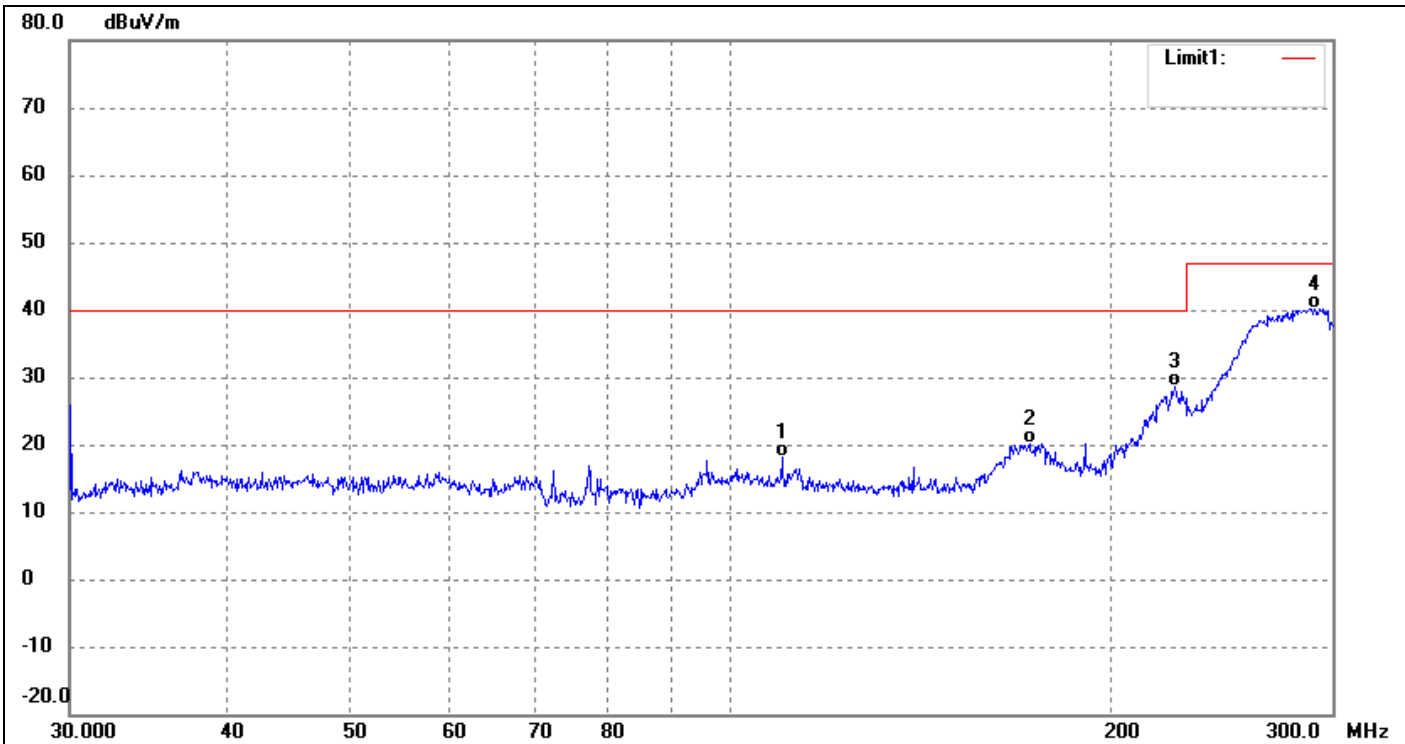

No.	Frequency (MHz)	Reading (dBuV)	Correct dB/m	Result (dBuV/m)	Limit (dBuV/m)	Over (dB)	Remark
1	109.9313	34.67	-16.62	18.05	40.00	-21.95	QP
2	172.6320	39.13	-19.06	20.07	40.00	-19.93	QP
3	224.9683	42.25	-13.53	28.72	40.00	-11.28	QP
4	290.4834	50.14	-9.94	40.20	47.00	-6.80	QP

Job No.:	RE	Polarization:	Vertical
Standard:	EN55015	Power Source:	AC 230V/50Hz
Test item:	Radiation Test	Date:	17/09/08/
Temp.(C)/Hum.(%RH):	22(C)/54%RH	Time:	14/33/15
Note:			

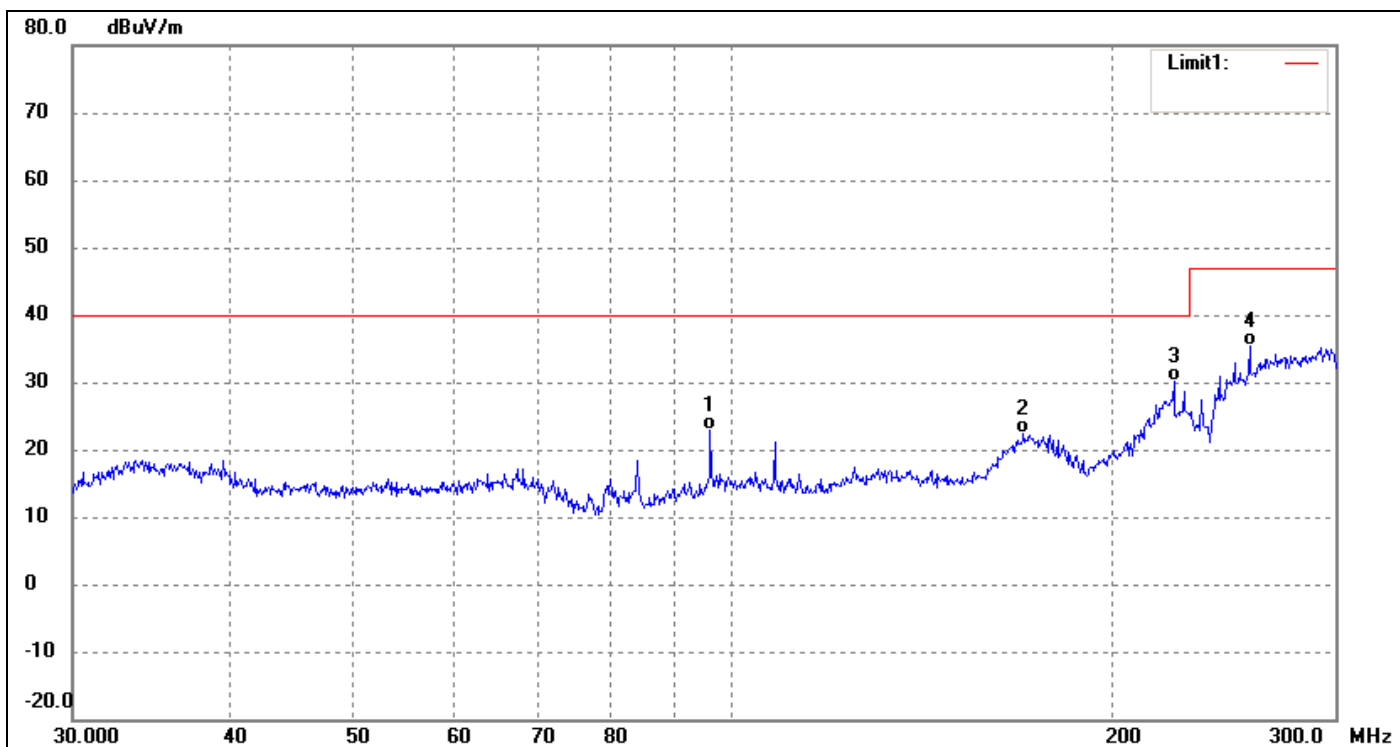

No.	Frequency (MHz)	Reading (dBuV)	Correct (dB/m)	Result (dBuV/m)	Limit (dBuV/m)	Over (dB)	Remark
1	95.9669	39.99	-17.15	22.84	40.00	-17.16	QP
2	169.8718	41.44	-19.05	22.39	40.00	-17.61	QP
3	223.4196	43.84	-13.63	30.21	40.00	-9.79	QP
4	256.5200	47.17	-11.90	35.27	47.00	-11.73	QP

Model GU10-6-30/A159/17 test data

Job No.:	RE	Polarization:	Horizontal
Standard:	EN55015	Power Source:	AC 230V/50Hz
Test item:	Radiation Test	Date:	17/09/08/
Temp.(C)/Hum.(%RH):	22(C)/54%RH	Time:	14/28/23
Note:			

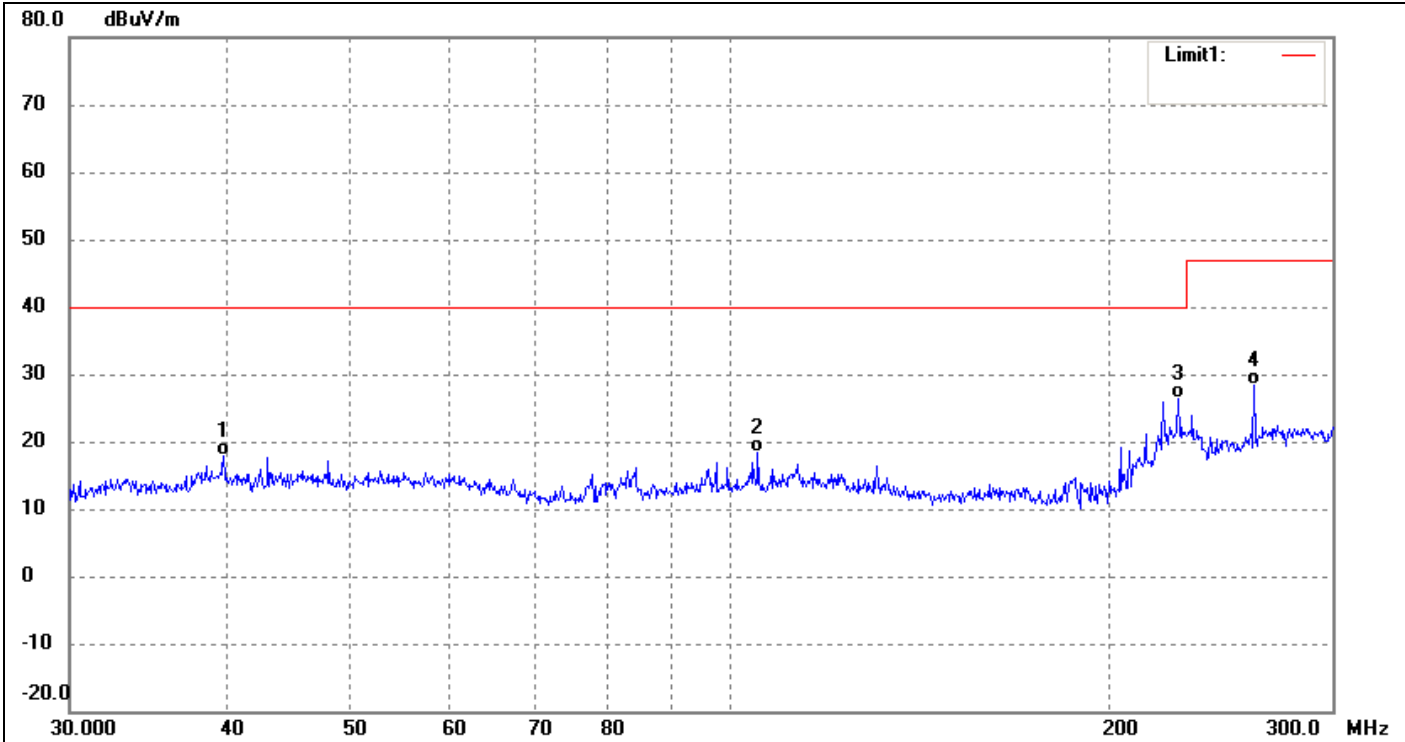

No.	Frequency (MHz)	Reading (dBuV)	Correct (dB/m)	Result (dBuV/m)	Limit (dBuV/m)	Over (dB)	Remark
1	39.7302	34.57	-16.57	18.00	40.00	-22.00	QP
2	105.2256	34.92	-16.61	18.31	40.00	-21.69	QP
3	226.5277	39.76	-13.42	26.34	40.00	-13.66	QP
4	260.0886	40.12	-11.77	28.35	47.00	-18.65	QP

Job No.:	RE	Polarization:	Vertical
Standard:	EN55015	Power Source:	AC 230V/50Hz
Test item:	Radiation Test	Date:	17/09/08/
Temp.(C)/Hum.(%RH):	22(C)/54%RH	Time:	14/30/01
Note:			

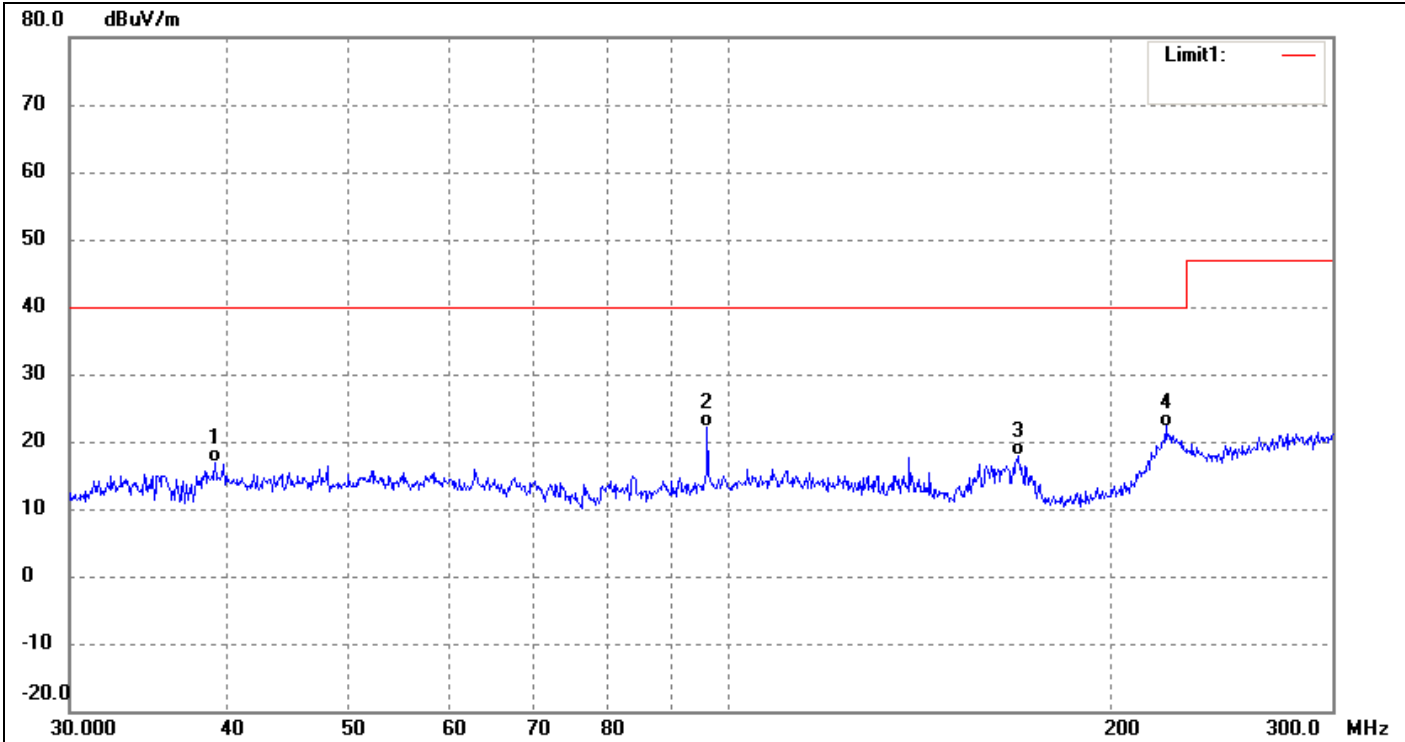

No.	Frequency (MHz)	Reading (dBuV)	Correct (dB/m)	Result (dBuV/m)	Limit (dBuV/m)	Over (dB)	Remark
1	39.0950	33.61	-16.68	16.93	40.00	-23.07	QP
2	95.9669	39.40	-17.15	22.25	40.00	-17.75	QP
3	169.0913	37.02	-19.05	17.97	40.00	-22.03	QP
4	221.3713	36.01	-13.76	22.25	40.00	-17.75	QP

Model R50-6-30/A115/19-8 test data

Job No.:	RE	Polarization:	Horizontal
Standard:	EN55015	Power Source:	AC 230V/50Hz
Test item:	Radiation Test	Date:	17/09/08/
Temp.(C)/Hum.(%RH):	22(C)/54%RH	Time:	14/24/18
Note:			

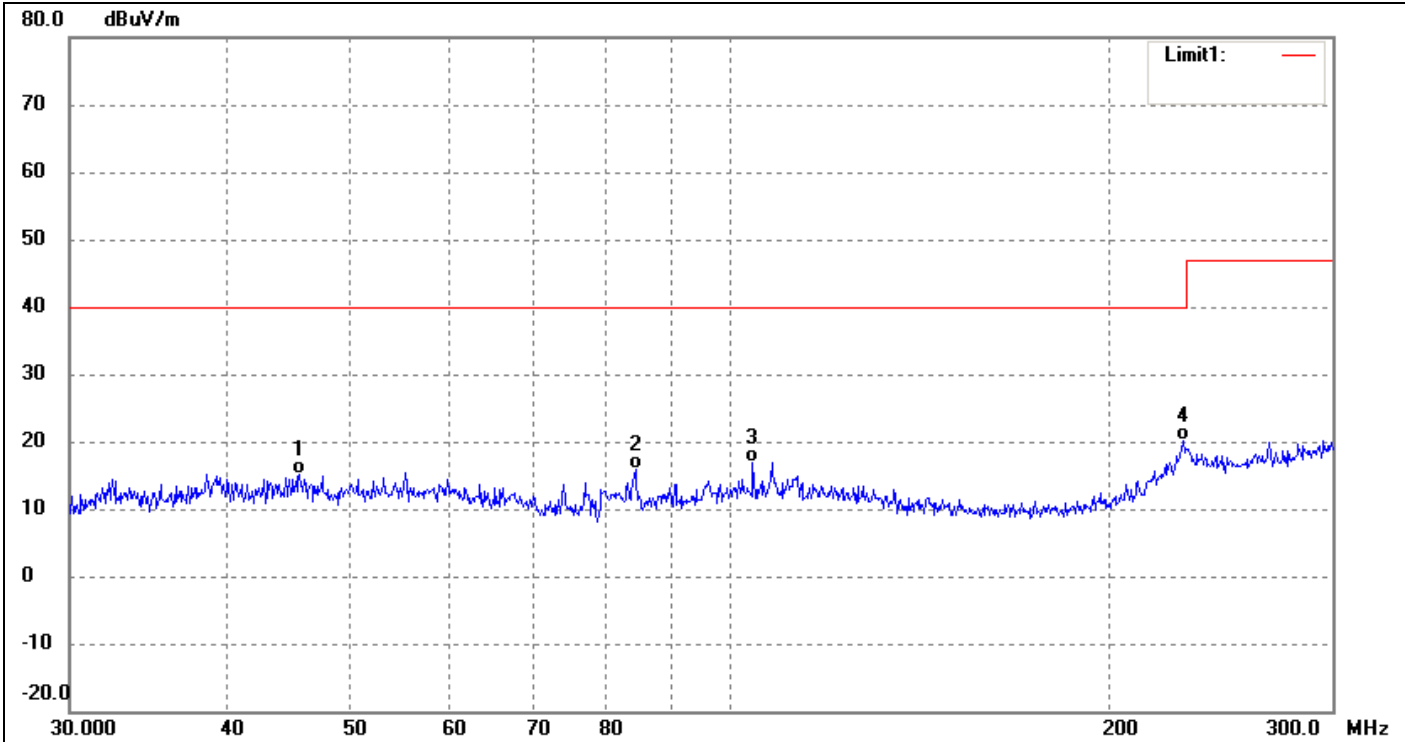

No.	Frequency (MHz)	Reading (dBuV)	Correct (dB/m)	Result (dBuV/m)	Limit (dBuV/m)	Over (dB)	Remark
1	45.6164	31.57	-16.49	15.08	40.00	-24.92	QP
2	84.1630	34.92	-19.10	15.82	40.00	-24.18	QP
3	104.2608	33.51	-16.60	16.91	40.00	-23.09	QP
4	228.6237	33.44	-13.29	20.15	40.00	-19.85	QP

Job No.:	RE	Polarization:	Vertical
Standard:	EN55015	Power Source:	AC 230V/50Hz
Test item:	Radiation Test	Date:	17/09/08/
Temp.(C)/Hum.(%RH):	22(C)/54%RH	Time:	14/23/11
Note:			

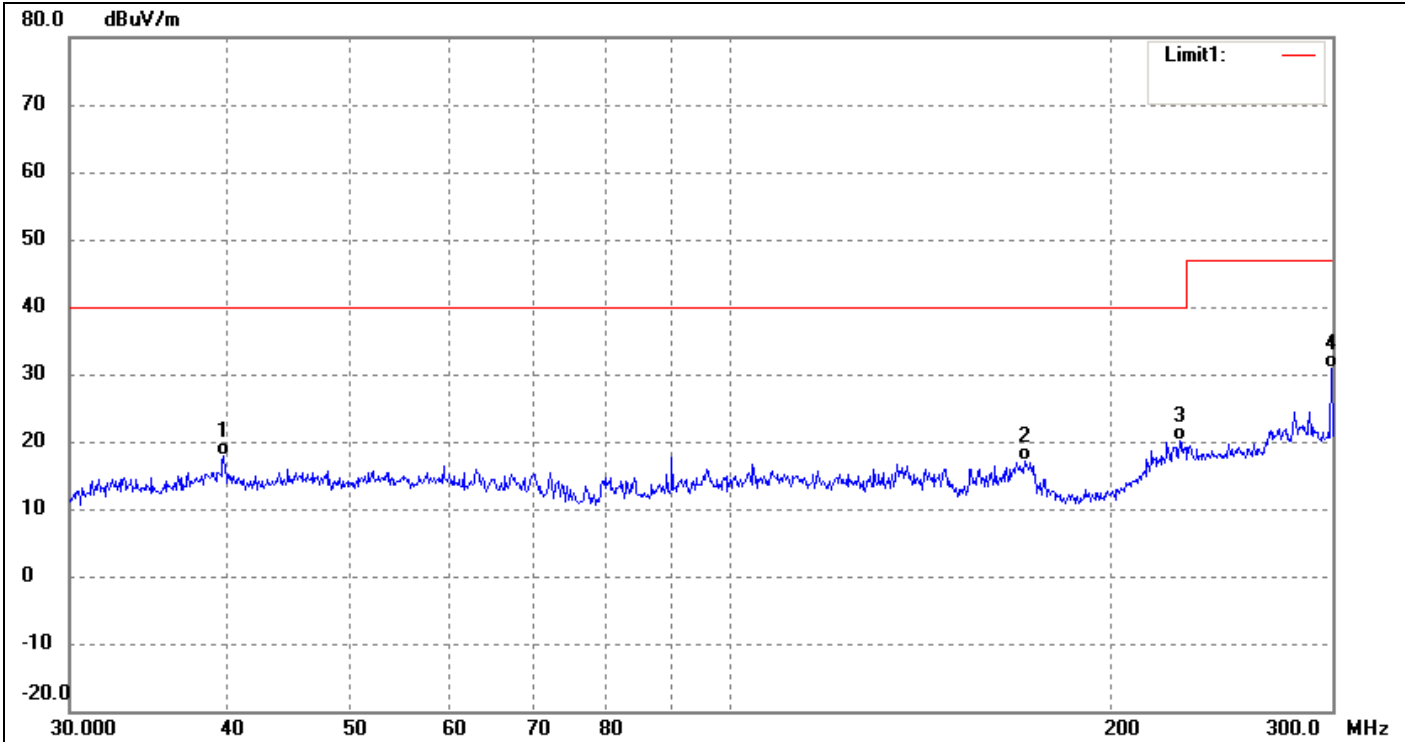

No.	Frequency (MHz)	Reading (dBuV)	Correct (dB/m)	Result (dBuV/m)	Limit (dBuV/m)	Over (dB)	Remark
1	39.7301	34.35	-16.57	17.78	40.00	-22.22	QP
2	171.0493	36.15	-19.05	17.10	40.00	-22.90	QP
3	227.0499	33.58	-13.39	20.19	40.00	-19.81	QP
4	299.3100	40.39	-9.62	30.77	47.00	-16.23	QP

Model R63-6-XX/A125/19-8 test data

Job No.:	RE	Polarization:	Horizontal
Standard:	EN55015	Power Source:	AC 230V/50Hz
Test item:	Radiation Test	Date:	17/09/08/
Temp.(C)/Hum.(%RH):	22(C)/54%RH	Time:	14/19/45
Note:			

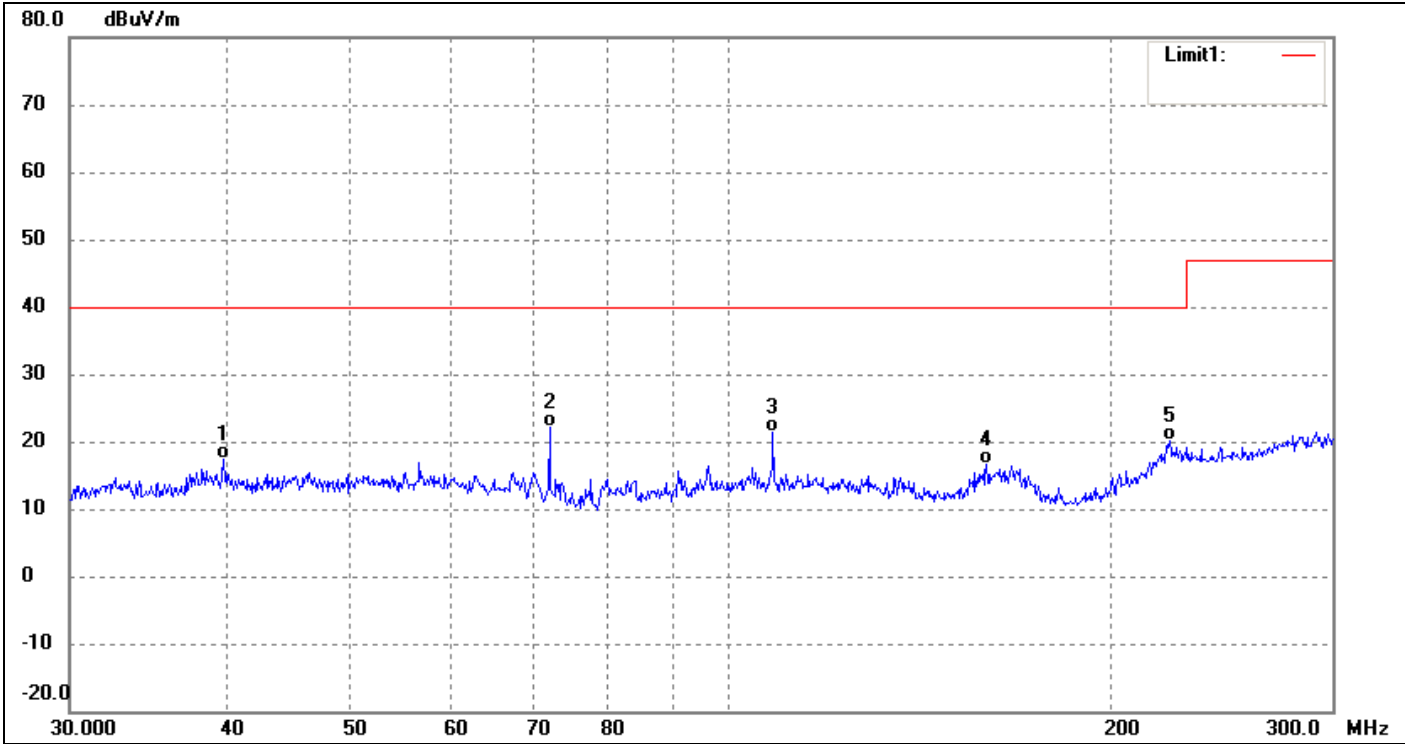

No.	Frequency (MHz)	Reading (dBuV)	Correct (dB/m)	Result (dBuV/m)	Limit (dBuV/m)	Over (dB)	Remark
1	39.7302	34.05	-16.57	17.48	40.00	-22.52	QP
2	71.9650	40.97	-18.96	22.01	40.00	-17.99	QP
3	108.1736	37.90	-16.61	21.29	40.00	-18.71	QP
4	159.6325	35.61	-19.08	16.53	40.00	-23.47	QP
5	222.9057	33.75	-13.66	20.09	40.00	-19.91	QP

Job No.:	RE	Polarization:	Vertical
Standard:	EN55015	Power Source:	AC 230V/50Hz
Test item:	Radiation Test	Date:	17/09/08/
Temp.(C)/Hum.(%RH):	22(C)/54%RH	Time:	14/18/01
Note:			

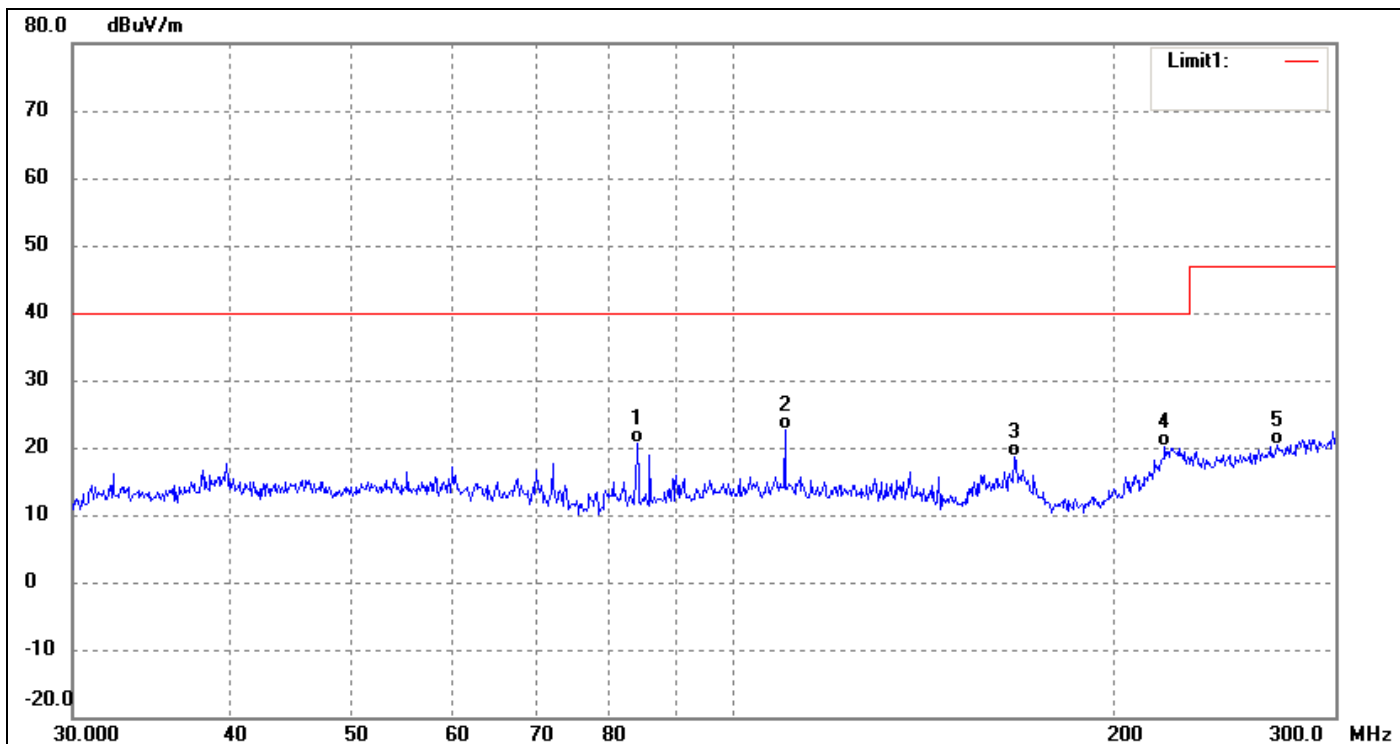

No.	Frequency (MHz)	Reading (dBuV)	Correct dB/m	Result (dBuV/m)	Limit (dBuV/m)	Over (dB)	Remark
1	83.9694	39.82	-19.13	20.69	40.00	-19.31	QP
2	109.9313	39.35	-16.62	22.73	40.00	-17.27	QP
3	167.1557	37.66	-19.05	18.61	40.00	-21.39	QP
4	219.8474	34.05	-13.87	20.18	40.00	-19.82	QP
5	269.8493	31.41	-11.09	20.32	47.00	-26.68	QP

4.4 Voltage Changes, Voltage Fluctuations and Flicker

This part is concerned with the limitation of voltage fluctuations and flicker impressed on the public low-voltage system.

4.4.1 Limits

Value	Limit
Pst	1,0
Plt	0,65
dt	3,3%
dc	3,3%
dmax	4,0%

Note: Pst and Plt evaluations are required only for lighting equipment which is likely to produce flicker, for example: disco lighting and automatically regulated equipment.

4.4.2 Measurement test procedure

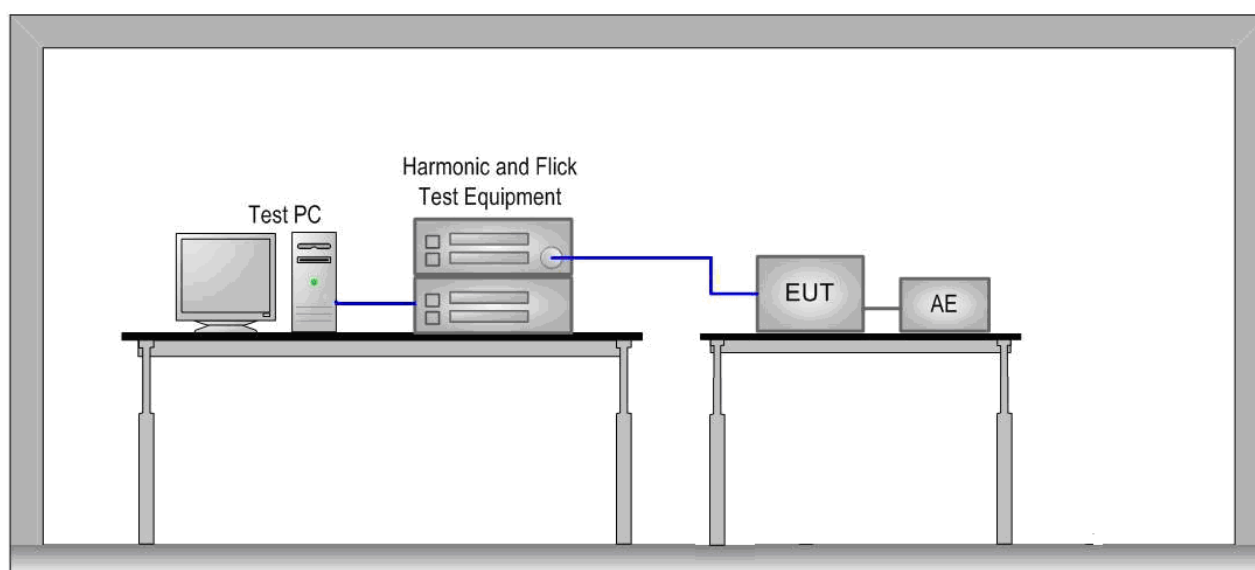

The equipment under test is placed on a wooden table with a height of 0,8 m in the EMC lab. The voltage changes, fluctuations and flicker were measured at the supply terminals of the EUT.

4.4.3 Results

Model GU10-6-30/K157/24 test data

Parameter values recorded during the test:

Vrms at the end of test (Volt):	229.88		
Highest dt (%):	0.00	Test limit (%):	3.30 Pass
Time(mS) > dt:	0.0	Test limit (mS):	500.0 Pass
Highest dc (%):	0.00	Test limit (%):	3.30 Pass
Highest dmax (%):	0.00	Test limit (%):	4.00 Pass

Model GU10-6-30/A159/17 test data**Parameter values recorded during the test:**

Vrms at the end of test (Volt):	229.89			
Highest dt (%):	0.00	Test limit (%):	3.30	Pass
Time(mS) > dt:	0.0	Test limit (mS):	500.0	Pass
Highest dc (%):	0.00	Test limit (%):	3.30	Pass
Highest dmax (%):	0.00	Test limit (%):	4.00	Pass

Model R50-6-30/A115/19-8 test data**Parameter values recorded during the test:**

Vrms at the end of test (Volt):	229.82			
Highest dt (%):	0.35	Test limit (%):	3.30	Pass
Time(mS) > dt:	0.0	Test limit (mS):	500.0	Pass
Highest dc (%):	0.00	Test limit (%):	3.30	Pass
Highest dmax (%):	0.36	Test limit (%):	4.00	Pass

Model R63-6-XX/A125/19-8 test data**Parameter values recorded during the test:**

Vrms at the end of test (Volt):	229.95			
Highest dt (%):	0.00	Test limit (%):	3.30	Pass
Time(mS) > dt:	0.0	Test limit (mS):	500.0	Pass
Highest dc (%):	0.00	Test limit (%):	3.30	Pass
Highest dmax (%):	0.00	Test limit (%):	4.00	Pass

5 Immunity Test

5.1 Performance Criteria Description in Clause 4 of EN 61547

Criterion A:	During the test, no change of the luminous intensity shall be observed and the regulating control, if any, shall operate during the test as intended.
Criterion B:	During the test, the luminous intensity may change to any value. After the test, the luminous intensity shall be restored to its initial value within 1 min. Regulating controls need not function during the test, but after the test, the mode of the control shall be the same as before the test provided that during the test no mode changing commands were given.
Criterion C:	During and after the test, any change of the luminous intensity is allowed and the lamp(s) may be extinguished. After the test, within 30 min, all functions shall return to normal, if necessary by temporary interruption of the mains supply and/or operating the regulating control. Additional requirement for lighting equipment incorporating a starting device: After the test, the lighting equipment is switched off. After half an hour, it is switched on again. The lighting equipment shall start and operate as intended.

5.2 Conditions during testing

The test shall be applied while the equipment is operated as intended under the normal operating conditions as laid down in the relevant product standard at stabilized luminous (radiant) flux and at normal laboratory conditions. Testing is only required at one combination of supply voltage and frequency, as specified by the manufacturer. Equipment including a regulating control shall be tested at a light output level of 50 % \pm 10 %. The lamp load of the equipment under test shall be the maximum allowed. Luminaires and independent auxiliaries shall be tested with lamps for which they are intended. Where equipment can operate with lamps of different wattages, lamps of maximum wattage shall be applied. For independent auxiliaries, the length of the cables between device and lamp shall be 3 m unless the manufacturer prescribes another length.

5.3 ESD

5.3.1 Test Procedures

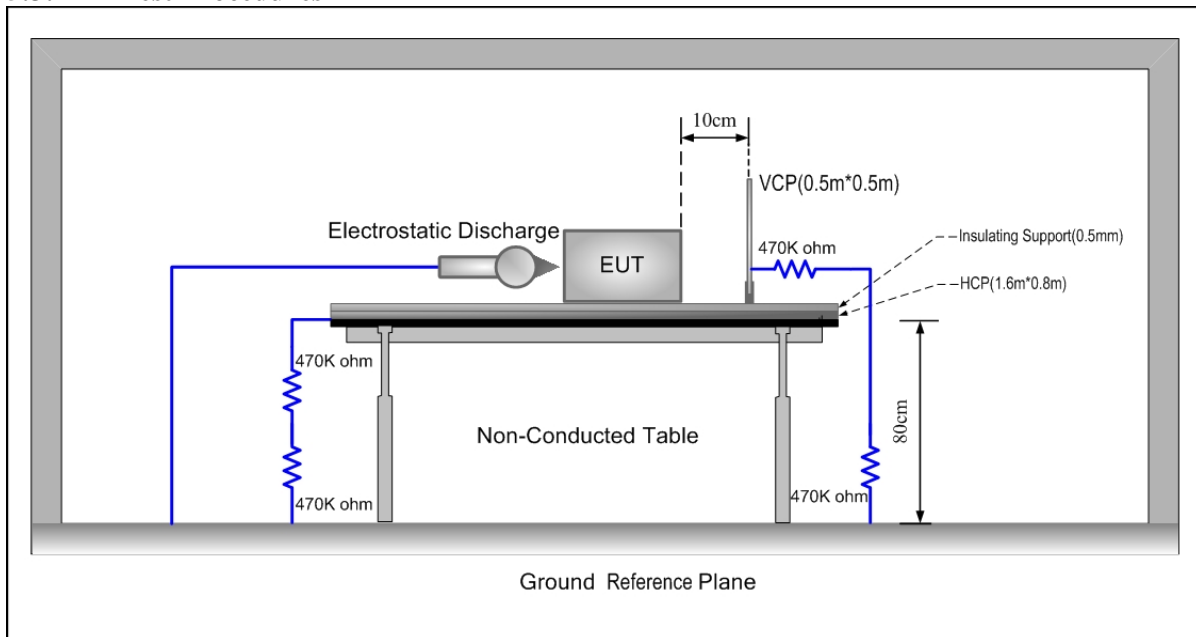

1. Contact discharge was applied only to conductive surfaces of the EUT. Air discharge was applied only to non-conducted surfaces of the EUT.
2. The EUT was put on a 0.8m high wooden table for table-top equipment or 0.1m high for floor standing equipment standing on the ground reference plane (GRP).
3. A horizontal coupling plane(HCP) 1.6m by 0.8m in size was placed on the table, and the EUT with its cables were isolated from the HCP by an insulating support thick than 0.5mm. The VCP 0.5m by 0.5m in size while HCP were constructed from the same material type and thickness as that of the GRP, and connected to the GRP via a 470kΩ resistor at each end. The distance between EUT and any of the other metallic surfaces excepted the GRP, HCP and VCP was greater than 1m.
4. During the contact discharges, the tip of the discharge electrode was touching the EUT before the discharge switch is operated. During the air discharges, the round discharge tip of the discharge electrode was approached as fast as possible to touch the EUT. After each discharge, the ESD generator was removed from the EUT, the generator is then retriggered for a new single discharge. For ungrounded product, a discharge cable with two resistances was used after each discharge to remove remnant electrostatic voltage. 10 times of each polarity single discharge were applied to HCP and VCP.

5.3.2 Results

Models GU10-6-30/K157/24, GU10-6-30/A159/17, R50-6-30/A115/19-8, R63-6-XX/A125/19-8

Test point	Table (T) Floor (F)	Contact (C) Air (A)	Voltage (kV)	Number of discharge	Polarity (+ / -)	Opinion
Air discharge	T	A	±2, ±4, ±8	Mini 20/point	+ / -	A
Contact discharge	T	C	±2, ±4	Mini 20/point	+ / -	A
HCP	T	C	±2, ±4	Mini 20/point	+ / -	A
VCP	T	C	±2, ±4	Mini 20/point	+ / -	A

A: no loss of function.

5.4 Radio frequency electromagnetic fields

5.4.1 Measurement procedure

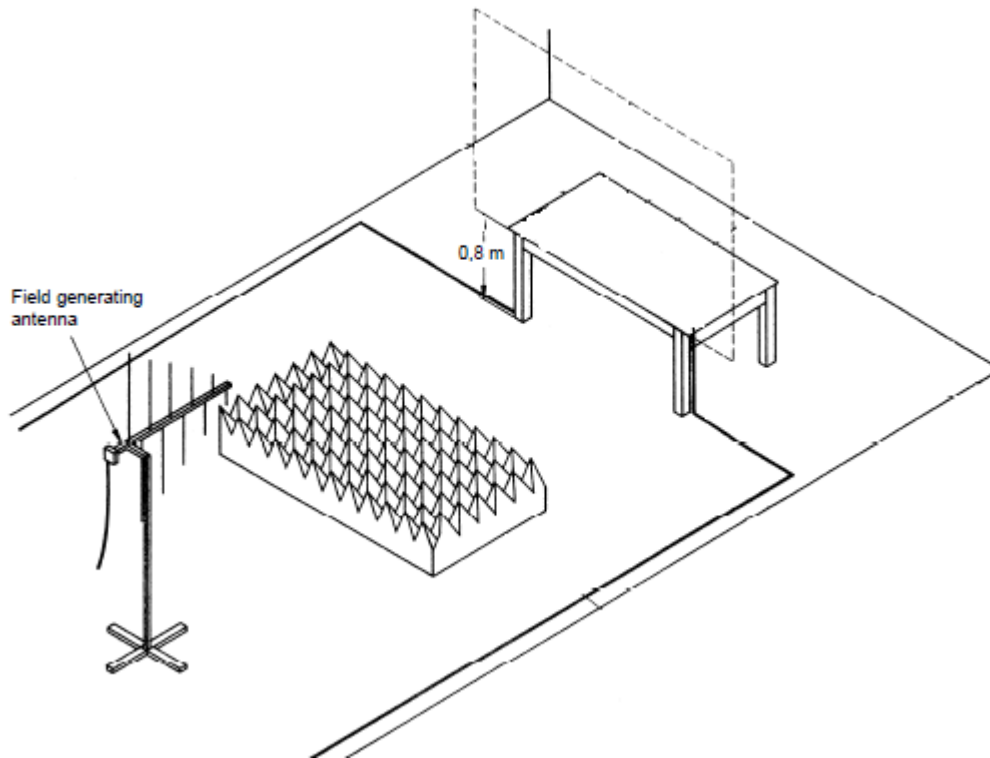

1. The EUT was placed on 0.8m high wooden table for table-top equipment. For floor standing equipment, the EUT was placed on a 0.1m high wooden support above the GRP. The tests normally shall be performed with the generating antenna facing each of four sides of the EUT. When equipment can be used in different orientations (e.g. vertical or horizontal) the test shall be performed on all possible sides of the EUT.
2. The tests are carried out with a field strength by 3 V/m (measured in the unmodulated field) with amplitude modulated signal by a depth of 80 % by a sinusoidal audio signal of 1 kHz. The logarithmic step was 1% and the dwell time was 3s dependent of the EUT cycle time. Test was performed on subcontractor.

5.4.2 Results

Models GU10-6-30/K157/24, GU10-6-30/A159/17, R50-6-30/A115/19-8, R63-6-XX/A125/19-8

Frequency Range	Field Strength	Modulation	Antenna Polarity	Opinion
80MHz-1GHz	3V/m	80% AM 1kHz	Horizontal	A
80MHz-1GHz	3V/m	80% AM 1kHz	Vertical	A

A: no loss of function.

5.5 Electrical Fast Transients

5.5.1 Measurement procedure

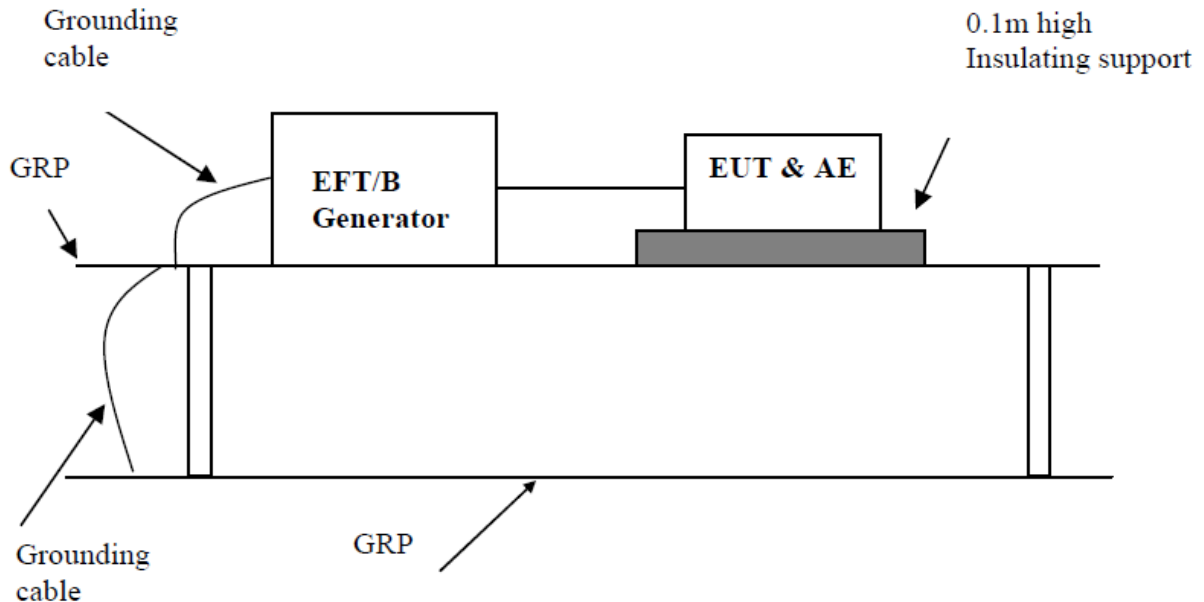

1. The EUT was placed on a ground reference plane (GRP) insulated by an insulating support 0.1 m thick and the GRP was placed on a 0.8m high wooden table for table-top equipment. For floor standing equipment, the EUT was placed on a 0.1m high wooden support above the GRP.
2. The GRP shall project beyond the EUT and the clamp by at least 0.1m on all sides. The distance between the EUT and any other of the metallic surface except the GRP was greater than 0.5m. All cables to the EUT were placed on the insulating support 0.1m above GRP. Cables not subject to EFT were routed as far as possible from cable under test to minimize the coupling between the cables.
3. The length of signal and power cable between the EUT and EFT generator was 0.5m. If the cable is a non-detachable supply cable more than 0.5m, the excess length of this cable shall be folded to avoid a flat coil and situated at a distance of 0.1m above the GRP.

5.5.2 Results

Models GU10-6-30/K157/24, GU10-6-30/A159/17, R50-6-30/A115/19-8, R63-6-XX/A125/19-8

Test port	Voltage (kV)	Polarity (+ / -)	Duration (s or min)	Waveform Tr / Th	Repetition Frequency (kHz)	Opinion
a.c. port, L	1	+/-	2 min	5/50 ns	5	A
a.c. port, N	1	+/-	2 min	5/50 ns	5	A
a.c. port, L+N	1	+/-	2 min	5/50 ns	5	A

A: no loss of function.

5.6 Injected currents(RF continues conducted)

5.6.1 Measurement procedure

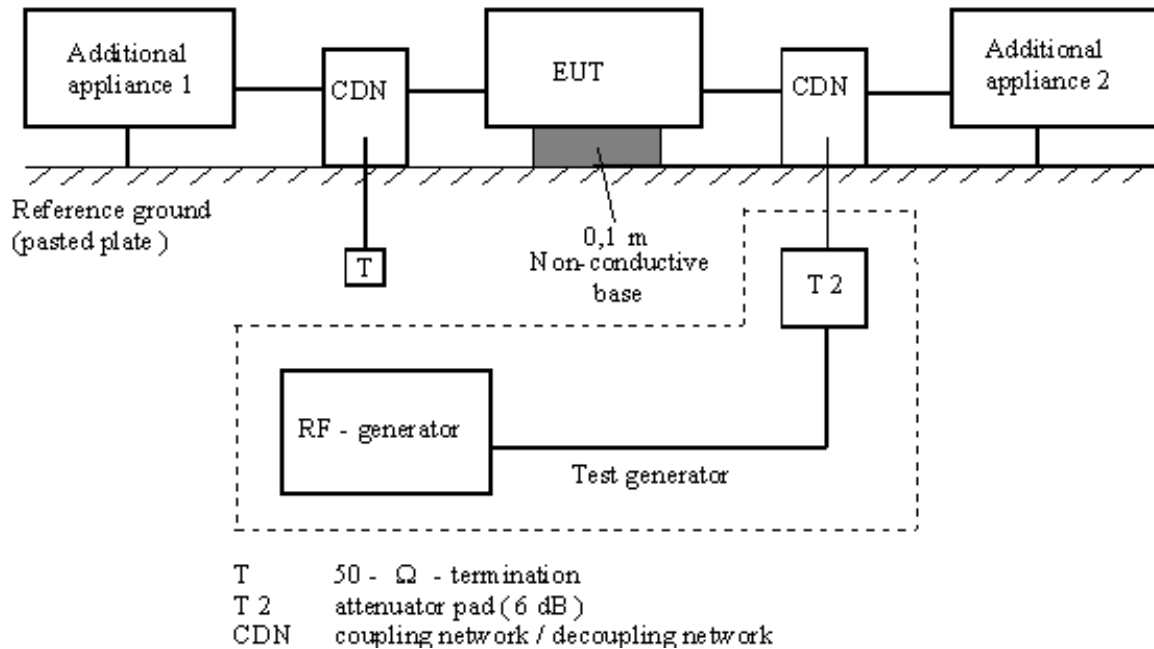

1. The EUT was placed on an insulating support of 0.1m height above a ground reference Plane, arranged and connected to satisfy its functional requirement. All cables exiting the EUT was supported at a height of at least 30 mm above the ground reference plane.
2. The coupling and decoupling devices were required, they were located between 0,1 m and 0,3 m from the EUT. This distance was to be measured horizontally from the projection of the EUT on to the ground reference plane to the coupling and decoupling device.
3. The frequency range was swept from 150 kHz to 80 MHz, using the signal levels established during the setting process, and with the disturbance signal 80 % amplitude modulated with a 1 kHz sine wave, pausing to adjust the RF signal level or to change coupling devices as necessary. Where the frequency was swept incrementally, the step size does not exceed 1 % of the preceding frequency value. The dwell time of the amplitude modulated carrier at each frequency was not less than the time necessary for the EUT to be exercised and to respond, and was not less than 3 s.

5.6.2 Results

Models GU10-6-30/K157/24, GU10-6-30/A159/17, R50-6-30/A115/19-8, R63-6-XX/A125/19-8

Test port	Voltage (e.m.f.)	Modulation	Frequency Range	Opinion
AC power line	3V	80% AM 1 kHz	150 kHz - 80 MHz	A

A: no loss of function.

5.7 Surge Immunity

5.7.1 Measurement procedure

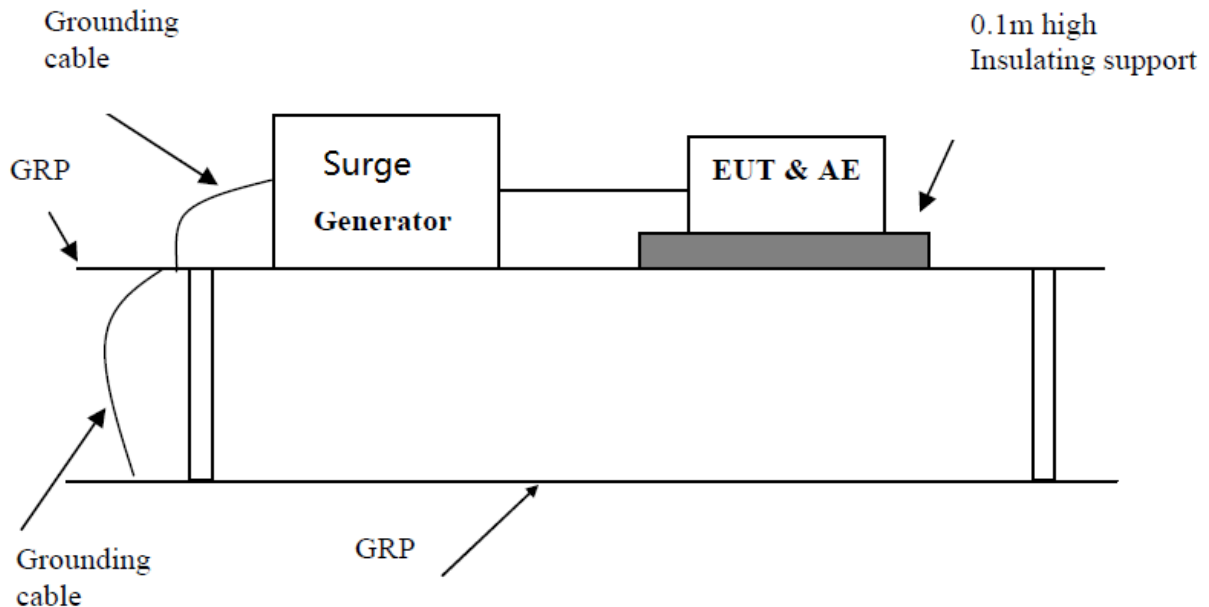

1. The EUT was placed on a ground reference plane (GRP) insulated by an insulating support 0.1 m thick and the GRP was placed on a 0.8m high wooden table for table-top equipment. For floor standing equipment, the EUT was placed on a 0.1m high wooden support above the GRP.
2. The 1,2/50 μ s surge was to be applied to the EUT power supply terminals via the capacitive coupling network. Decoupling networks were required in order to avoid possible adverse effects on equipment not under test that may be powered by the same lines and to provide sufficient decoupling impedance to the surge wave so that the specified wave may be applied on the lines under test.
3. Pulses shall be applied to the a.c. voltage wave as follows; five positive polarity pulses at the 90° phase angle, five negative polarity pulses at the 270° phase angle.

5.7.2 Results

Models GU10-6-30/K157/24, GU10-6-30/A159/17, R50-6-30/A115/19-8, R63-6-XX/A125/19-8

Test port	Polarity (+ / -)	Voltage (kV)	Voltage Waveform	Current Waveform	Repetition Rate	Number of pulses	Opinion
a.c. port, L-N	+/-	0.5	1.2/50 μ s	8/20 μ s	1 per min	5 /point	B

A: no loss of function.

B: the appliance would not work normal (darkle) during test, but after test it would recover.

5.8 Voltage dips and Interruption

5.8.1 Measurement procedure

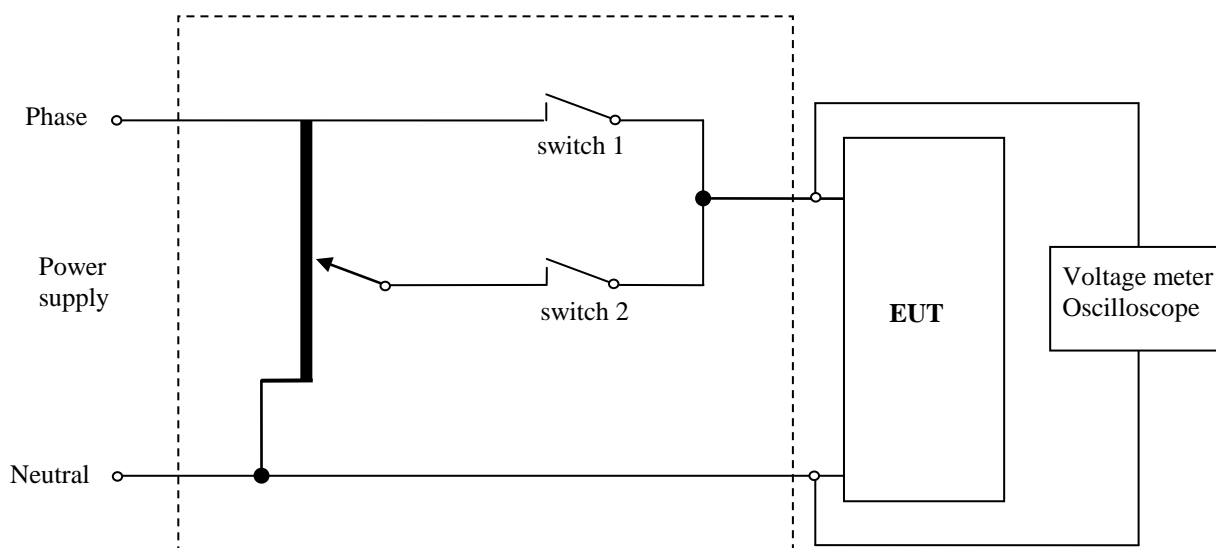

1. The EUT was placed on a ground reference plane (GRP) insulated by an insulating support 0,1 m thick and the GRP was placed on a 0.8m high wooden table for table-top equipment. For floor standing equipment, the EUT was placed on a 0.1m high wooden support above the GRP.
2. The test was performed with the EUT connected to the test generator with the shortest power supply cable as specified by the EUT manufacturer. Changes to the voltage level shall occur at a zero crossing point in the a.c. voltage waveform.
3. The EUT was tested for each selected combination of test level and duration with a sequence of three dips /interruptions with intervals of 10 s minimum. Each representative mode of operation was tested.

5.8.2 Results

Models GU10-6-30/K157/24, GU10-6-30/A159/17, R50-6-30/A115/19-8, R63-6-XX/A125/19-8

Reduction of supply voltage	Test level in % U_T	Duration in parts of period (in ms)	Opinion
100%	0	0,5 (10 ms)	B
30 %	70	10 (200 ms)	B

A: no loss of function.

B: the appliance would not work normal (darkle) during test, but after test it would recover.

6 Test setup Photos

Radiated Disturbance Test Setup



Conducted Emission Test Setup



Radiated Electromagnetic Disturbances Test Setup



Current Harmonics /Voltage Flicker Test Setup



Electrostatic Discharge Test Setup



Radio Frequency Electromagnetic Fields Test Setup

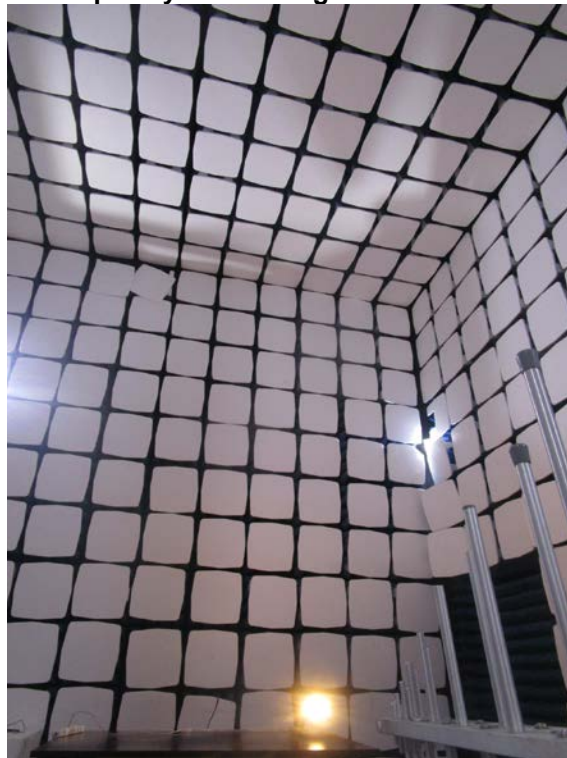

**Electrical Fast Transients Immunity/ Surge Immunity/ Voltage DIPS
and Interruption Test Setup**



Injected Currents (RF common mode) Test Setup

